

# **AVerMedia® AVerVision300p**

## **User Manual**

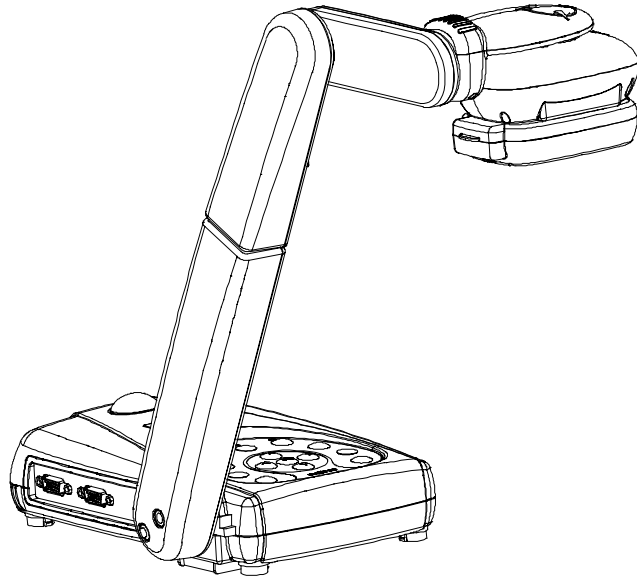

**AVerMedia®**  
Document Camera



## **FCC NOTICE (Class A)**



This device complies with Part 15 of the FCC Rules. Operation is subject to the following two conditions: (1) this device may not cause harmful interference, and (2) this device must accept any interference received, including interference that may cause undesired operation.

NOTE- This equipment has been tested and found to comply with the limits for a Class A digital device, pursuant to Part 15 of the FCC Rules. These limits are designed to provide reasonable protection against harmful interference when the equipment is operated in a commercial environment. This equipment generates, uses and can radiate radio frequency energy and, if not installed and used in accordance with the instructions, may cause harmful interference to radio communications. Operation of this equipment in a residential area is likely to cause harmful interference in which case the user will be required to correct the interference at his own expense.

## **CAUTION ON MODIFICATIONS**

To comply with the limits for the Class A digital device, pursuant to Part 15 of the FCC Rules, this device must be installed in computer equipment certified to comply with the Class A limits. All cables used to connect the computer and peripherals must be shielded and grounded. Operation with non-certified computers or non-shielded cables may result in interference to radio or television reception.

Changes and modifications not expressly approved by the manufacturer could void the user's authority to operate this equipment.

## **European Community Compliance Statement**



### **Class A**

This product is conformity with the protection requirements of EU Council Directives 89/336/EEC amended by 92/31/EEC on the laws of the Member States relating to electromagnetic compatibility.

Warning- This is a Class A product. In a domestic environment this product may cause radio interference in which case the user may be required to take adequate measures to correct this interference.

## **DISCLAIMER**

No warranty or representation, either expressed or implied, is made with respect to the contents of this documentation, its quality, performance, merchantability, or fitness for a particular purpose. Information presented in this documentation has been carefully checked for reliability; however, no responsibility is assumed for inaccuracies. The information contained in this documentation is subject to change without notice.

In no event will AVerMedia be liable for direct, indirect, special, incidental, or consequential damages arising out of the use or inability to use this product or documentation, even if advised of the possibility of such damages.

## **TRADEMARKS**

AVerMedia is registered trademarks of AVerMedia TECHNOLOGIES, Inc. IBM PC is a registered trademark of International Business Machines Corporation. Macintosh is a registered trademark of Apple Computer, Inc. Microsoft is a registered trademark and Windows is a trademark of Microsoft Corporation. All other products or corporate names mentioned in this documentation are for identification and explanation purposes only, and may be trademarks or registered trademarks of their respective owners.

## **COPYRIGHT**

© 2006 by AVerMedia TECHNOLOGIES, Inc. All rights reserved. No part of this publication may be reproduced, transmitted, transcribed, stored in a retrieval system, or translated into any language in any form by any means without the written permission of AVerMedia TECHNOLOGIES, Inc.



THE MARK OF CROSSED-OUT WHEELED BIN INDICATES THAT THIS PRODUCT MUST NOT BE DISPOSED OF WITH YOUR OTHER HOUSEHOLD WASTE. INSTEAD, YOU NEED TO DISPOSE OF THE WASTE EQUIPMENT BY HANDING IT OVER TO A DESIGNATED COLLECTION POINT FOR THE RECYCLING OF WASTE ELECTRICAL AND ELECTRONIC EQUIPMENT. FOR MORE INFORMATION ABOUT WHERE TO DROP OFF YOUR WASTE EQUIPMENT FOR RECYCLING, PLEASE CONTACT YOUR HOUSEHOLD WASTE DISPOSAL SERVICE OR THE SHOP WHERE YOU PURCHASED THE PRODUCT.

# Table of Contents

<b>Introduction</b> .....	<b>1</b>
<b>Package Contents</b> .....	<b>2</b>
Optional Accessories .....	3
<b>Technical Specifications</b> .....	<b>4</b>
<b>Installing and Setting Up the Hardware</b> .....	<b>5</b>
Connecting the Power Adapter .....	6
Connecting a VGA, Mac Display Monitor or LCD/DLP Projector .....	6
Connecting a TV .....	7
Connecting an IBM Compatible PC or Macintosh Computer .....	7
Connecting a Computer via USB connection .....	8
Installing the Optional Light Box.....	8
Connecting to a Microscope .....	9
<b>Adjusting the AVerVision300p</b> .....	<b>10</b>
Camera Head .....	10
Mechanical Arm .....	10
Light and Document Positioning Pointer .....	11
Anti-glare .....	11
<b>Using the Infrared Remote Control</b> .....	<b>12</b>
<b>Touch Button Control Panel</b> .....	<b>14</b>
<b>LED Panel</b> .....	<b>15</b>
<b>Infrared Sensor</b> .....	<b>15</b>
<b>Timer Function</b> .....	<b>16</b>
<b>Using the AVerVision Application</b> .....	<b>17</b>
Installing the Software.....	17
Application User Interface.....	18
<b>Image Download from AVerVision300p to PC</b> .....	<b>20</b>
<b>OSD Navigation Tree</b> .....	<b>21</b>
<b>Menu Functions</b> .....	<b>22</b>
<b>Troubleshooting</b> .....	<b>25</b>
<b>Limited Warranty</b> .....	<b>27</b>
Limitations of Warranty .....	27
Disclaimer of Warranty.....	27
Limitation of Liability.....	28
Governing Law and Your Rights.....	28



## Introduction

Thank you for purchasing the AVerMedia® AVerVision300p. This document camera displays any documents, negatives, transparencies and 3D objects onto a TV, LCD or DLP projector making presentations a snap.

The advanced features of the AVerVision300p make it a versatile and multifunctional product, making presentations easy. You can save still images with built-in flash memory and download to a PC. While connected to a PC via USB cable, you can also capture and save images and video clips to your PC. It also comes equipped with a full-featured remote control. AVerVision300p is an ideal presentation tool for academic, business, medical and the scientific community.

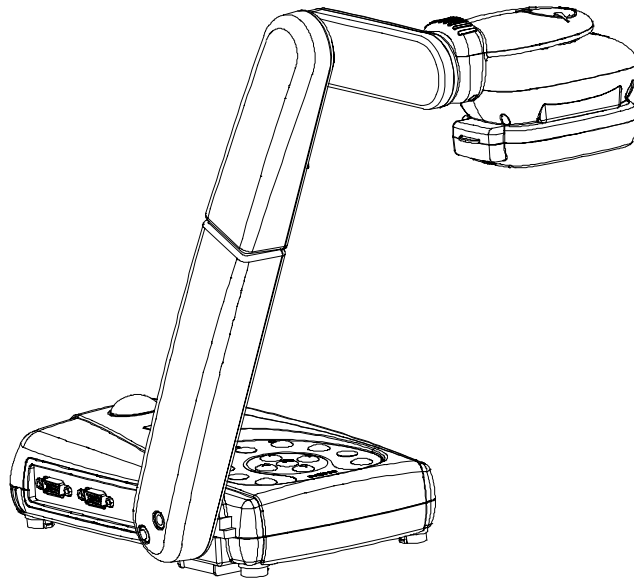

# Package Contents

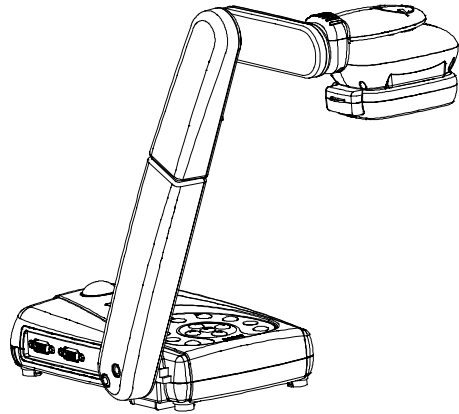

AVerMedia® AVerVision300p

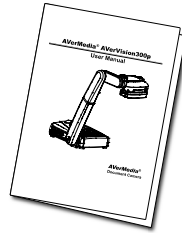

User Manual



Remote Control  
(batteries included)

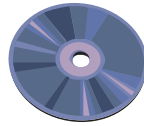

Driver CD



Anti-glare Sheet

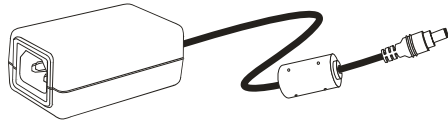

Power Adapter



RCA Cable



S-Video Cable



Power Cord

\* The power cord will vary depending on the standard power outlet of the country where it is sold.



Computer Extension Cable  
(VGA Cable)



USB Cable



**Optional Accessories**

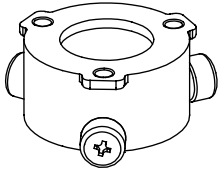

34mm  
Microscopic Adapter

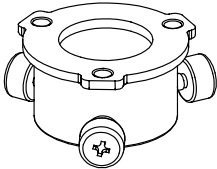

28mm  
Microscopic Adapter

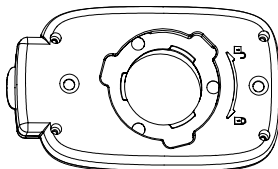

Microscopic Coupler

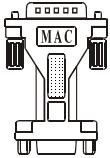

Monitor Adapter  
(for MAC)

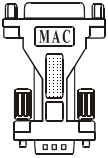

Computer Adapter  
(for MAC)

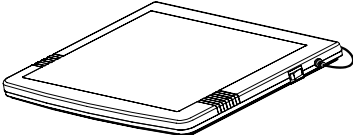

Light Box

# Technical Specifications

## Image

Sensor	1/2" progress scan CMOS
VGA Effective Pixels	790K 1024 (H) x 768 (V)
Frame Rate	24 fps (Max.)
White Balance	Auto / Manual
Exposure	Auto / Manual / Flicker / Night View
Image mode	Text / Graphics / High Frame
Effect	Color / B/W / Negative; Reverse; Mirror
Analog RGB output	XGA : 75 Hz, SVGA : 60 Hz, VGA : 60 Hz
H Sync. Signal	60K / 37.879K / 31.469 KHz, TTL level
V Sync. Signal	75Hz / 60Hz / 60 Hz, TTL level
Image Signal Level	0.7 Vpp
S-Video, Composite Video Output	NTSC / PAL
Image Capture	Up to 80 Frames
Built-in Memory	32MB NAND Flash Memory

## Optics

Lens	F3.0; Manual Focusing
Shooting Area	320mm x 240mm (Max.);
Zooming	Digital: 8x, AVERZOOM: 2x
Power Source	100-240V ~ 4.0-4.2A, 50-60 Hz
Consumption	5.9 Watts (lamp off); 8 Watts (Lamp on)

## Lighting

Lamp type	LED lamp with Laser Positioning Pointer
-----------	---

## Input/Output

VGA Input	15-Pins D-sub (VGA)
VGA Output	15-Pins D-sub (VGA)
S-Video	Mini-DIN Jack
Composite Video	RCA Jack
USB	USB1.1
DC 6V Output	Power Jack

## Dimension

Operating	220mm x 140mm x 500mm
Folded	380mm x 170mm x 55mm
Weight	2 kg (about 4.4 lb)

## Installing and Setting Up the Hardware

The ports on the back and side panel of the AVerVision300p enable you to connect the unit to a computer, graphics display monitor or LCD/ DLP projector, TV or other devices. Illustrated below are the ports that are located at the back and side panel of the AVerVision300p with their corresponding labels.

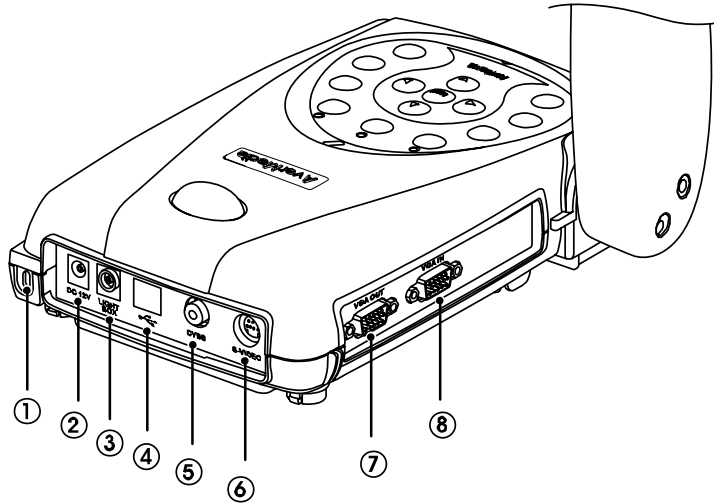

Port	Description
(1) Security Slot	Use this port to connect a Kensington compatible security lock.
(2) DC 12V (input)	Plug the power adapter into this port. (If turn off the AVerVision300p by disconnecting the power cord, please wait for 5 seconds to reconnect the power connector.)
(3) DC 6V (output)	Plug the optional light box into this port.
(4) USB1.1 Port	This port enables you to use AVerVision300p as a PC Camera or to download the captured images to your PC.
(5) VIDEO Port	The VIDEO Port enables you to output your camera or preview a picture from the built-in memory, on your TV.
(6) S-VIDEO Port	The S-VIDEO Port enables you to output your camera or preview a picture from the built-in memory, on your TV.
(7) VGA OUT Port	Use this port to connect to a VGA/ Mac monitor, LCD/DLP projector for your camera, PC presentation, or playback a picture from built-in memory.
(8) PC IN Port	Use this port to connect the AVerVision300p to the VGA output port of your computer. This enables you to input your computer video signal and pass it through to the VGA out port.

## Connecting the Power Adapter

You can connect the power adapter to a standard 100V~240V AC power source.

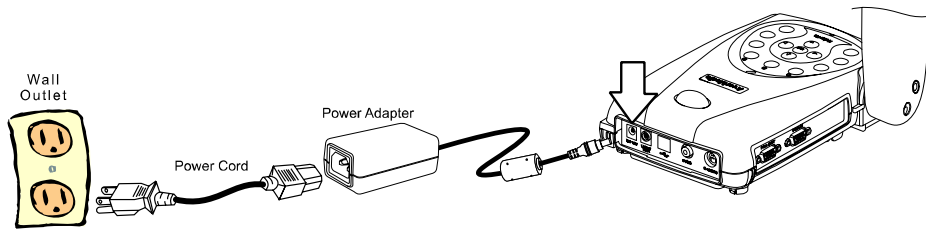

## Connecting a VGA, Mac Display Monitor or LCD/DLP Projector

AVerVision300p enables you to display a presentation on a VGA / MAC display monitor, or LCD/DLP projector with an outstanding video quality.

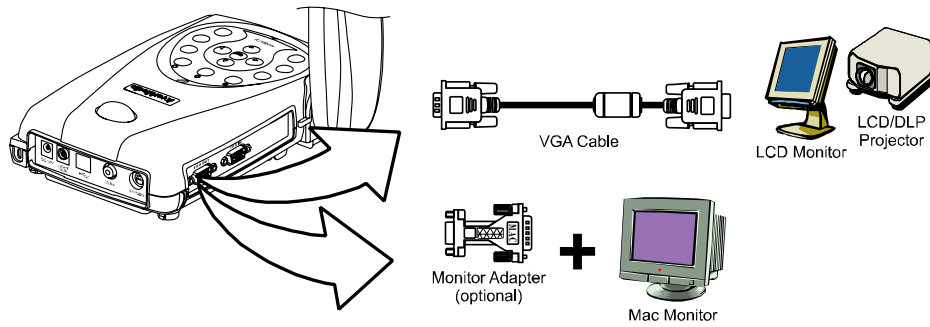

## Connecting a TV

To display a presentation on TV, connect AVerVision300p to your TV by using the Video Cable or S-Video cable, switch the output mode to TV system by pressing the **VGA / TV** button on the remote control or control panel. If you are using a SCART RGB monitor, connect it by using the RCA to SCART cable. (The SCART RGB cable is provided as an optional accessory cable with the AVerVision300p.)

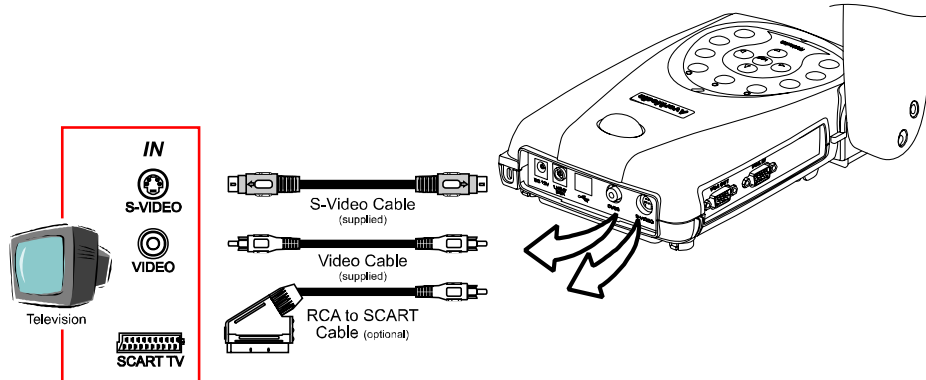

## Connecting an IBM Compatible PC or Macintosh Computer

You can connect the AVerVision300p to an IBM compatible PC, Macintosh, or notebook (laptop) computer. After physically connecting the unit to your PC, you can display an image from your computer by pressing the **PC** button on the unit's control panel or remote control.

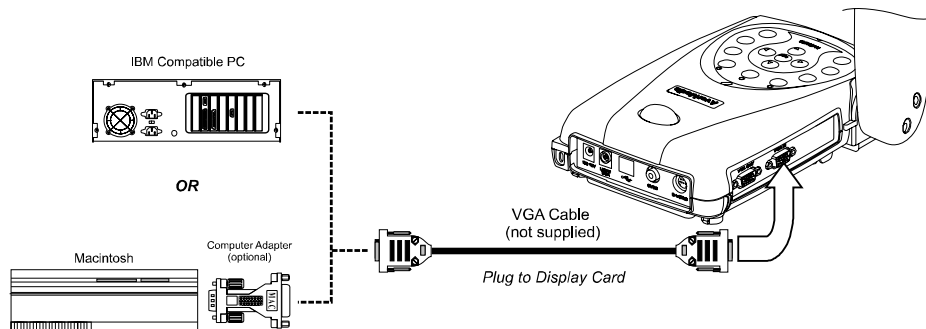

## Connecting a Computer via USB connection

Download the saved images from AVerVision300p's built-in memory to your computer or access the software application as a PC cam via the USB cable. Select the function through OSD, then connect it. (Refer to the section, *Using the AVerVision Application*, for more details.)

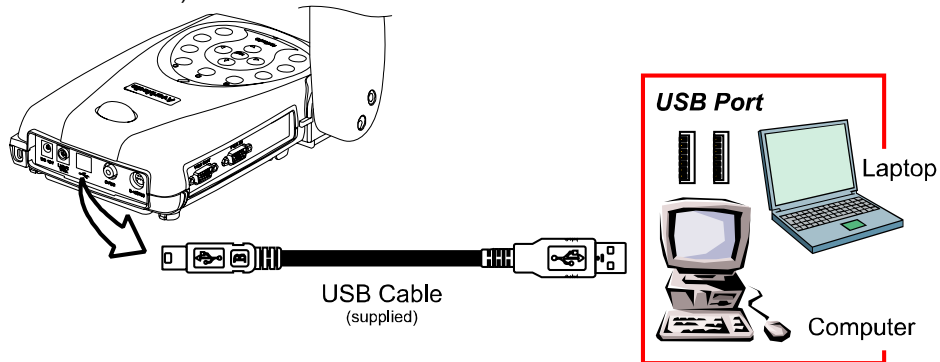

## Installing the Optional Light Box

Connecting an optional light box enables you to view x-rays, transparencies and negative slides.

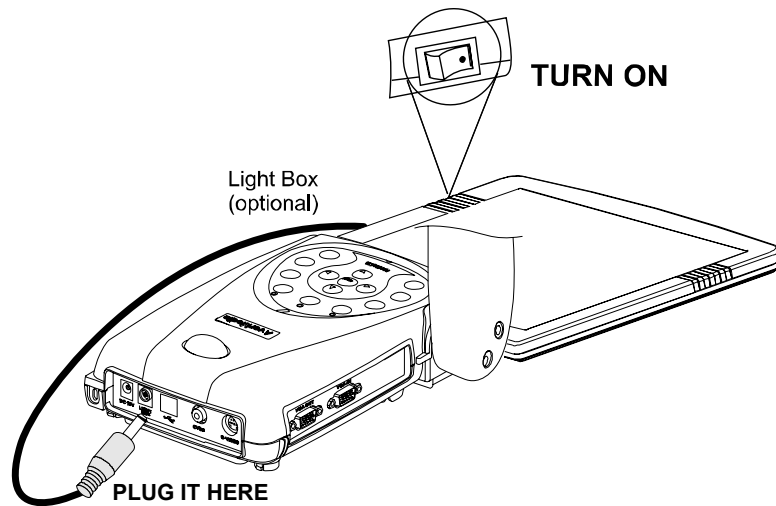

# Connecting to a Microscope

Connecting the AVerVision300p to a microscope enables you to examine microscopic objects on a larger screen without straining your eyes.

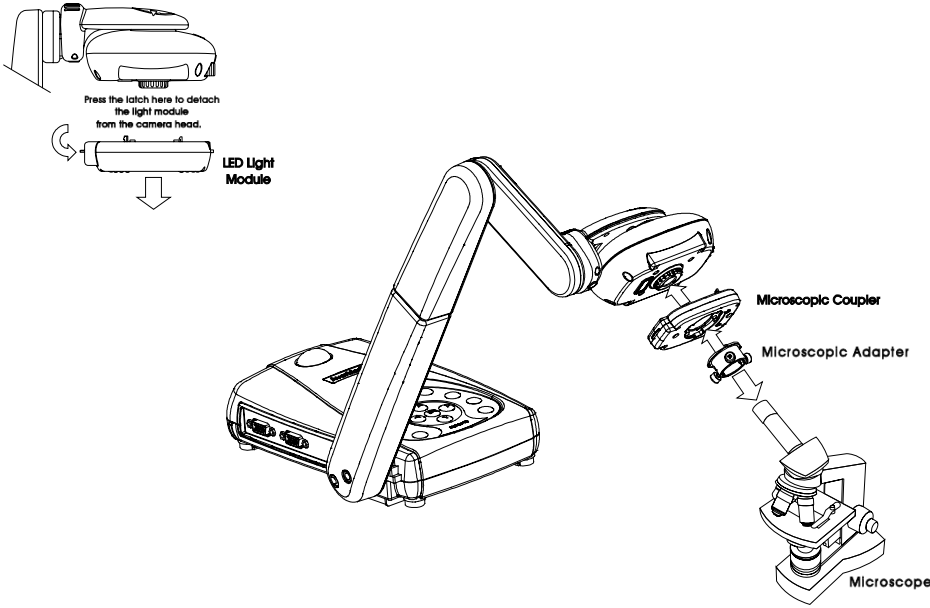

## Adjusting the AVerVision300p

This section provides illustrated useful tips on how to adjust the AVerVision300p to meet your needs.

### Camera Head

The camera head can be rotated 135 degrees from left to right. You can also manually adjust the focus from here to improve the quality of the pictures.

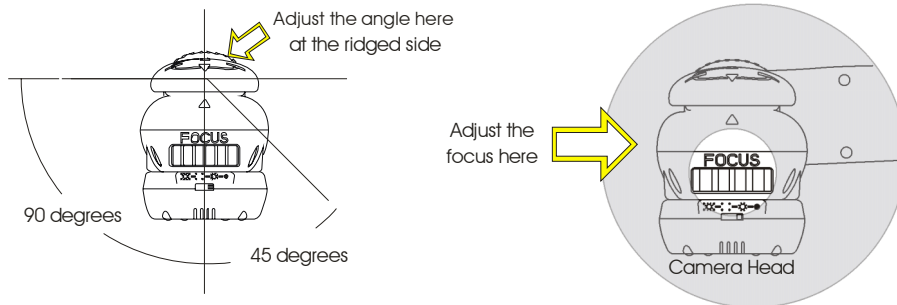

### Mechanical Arm

AVerVision300p features a mechanical arm that enables you to project an image to its full height for full A4 paper landscape viewing.

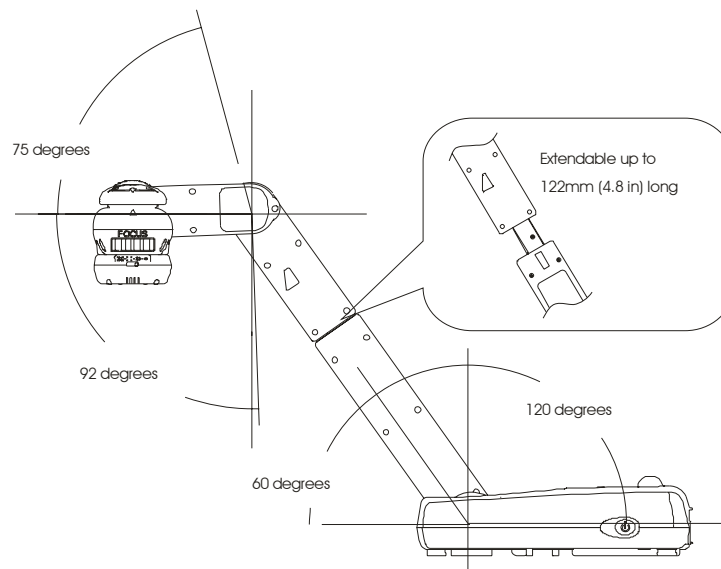



# Light and Document Positioning Pointer

A unique feature of the AVerVision300p is the four (4) laser positioning pointers that define the viewing area, enabling you to correctly position the object at the center under the camera's viewing area. 3 various light and laser position pointer settings are provided as follows.

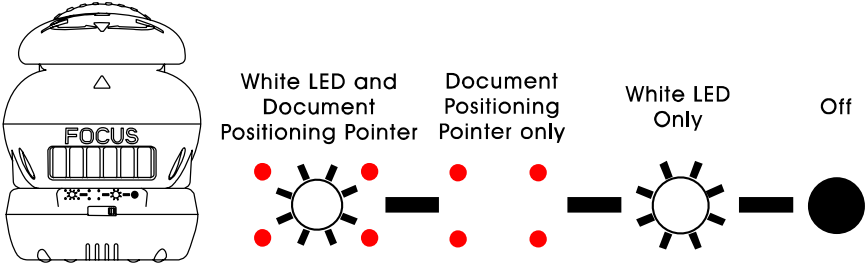

# Anti-glare



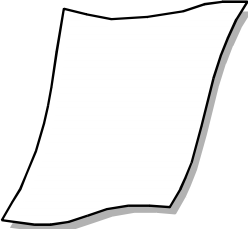

The anti-glare sheet is a special coated film that helps eliminate any glare you may encounter when you are displaying very shiny objects or glossy surfaces such as magazines, pictures, etc. Simply place the anti-glare sheet on top of the document to reduce the reflected light.



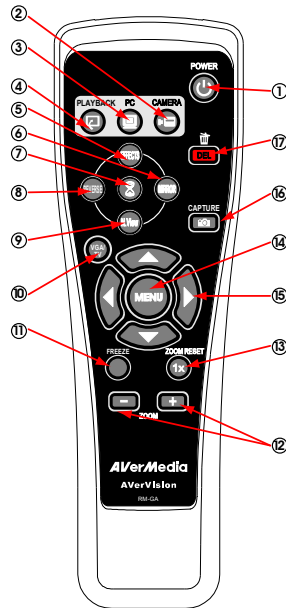











## Using the Infrared Remote Control

Use the AVerVision300p Remote Control to enhance your presentation, switch between (3) three presentation modes and access various features. To use the remote control, first insert the batteries (2 size “AAA” batteries are provided) into the battery compartment at the back of the remote. Use the figure and descriptions below to help you use the remote control.

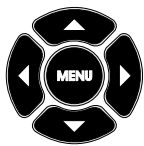

Name	Button	Function
(1) POWER		Turn the unit on/standby/off.
(2) CAMERA MODE		Switch to Camera mode and display the image from the AVerVision300p's built-in CMOS camera.
(3) PC MODE		Switch to PC mode and display the video signal from the RGB input port.
(4) PLAYBACK MODE		Switch to Playback mode and toggle to display 80-thumbnail images.
(5) EFFECTS		Convert and display the video in BW, Negative or Color. (camera mode only)

(6) MIRROR		Flip the image in Camera mode.
(7) TIMER		Display, start and hide the on-screen display timer. You can toggle to display or hide the remaining time when the timer countdown has started. (See Timer Function for more details)
(8) REVERSE		Rotate the image by 180°. (camera mode only)
(9) NIGHT VIEW		Turn on/off Night View. Use Night View when you are presenting in a low-light condition. The captured image however, appears in slow motion.
(10) VGA/TV		Switches between VGA (VGA Out) or TV (Composite Video/S-Video Out).
(11) FREEZE		Toggle to pause or resume the camera.
(12) ZOOM +/-		<ul style="list-style-type: none"> <li>- Zoom in and zoom out the picture digitally in Playback mode.</li> <li>- Zoom in and zoom out the image optically and digitally in Camera mode. When it reaches the maximum AVERZOOM level of about 2 times, you can still continue to digitally zoom in the image up to 1600%.</li> </ul>
(13) ZOOM RESET		Return to normal view (1x).
(14) MENU		Call up and exit the OSD main and sub-menu.
(15) ▲ ▼ ◀ ▶		<ul style="list-style-type: none"> <li>- Use ▲, ▼, ◀ and ▶ to make a selection and adjustment. And use ▶ to enter sub-menu. (See Menu Functions, for more details)</li> <li>- Use ▲, ▼, ◀ and ▶ to make a selection in 80-thumbnail images and press  to view the selected image.</li> </ul>
(16) CAPTURE		Photograph an image. The captured image is automatically stored in the memory source at 1024 x 768 resolution.
(17) DELETE		Remove the selected picture permanently in Playback mode.

## Touch Button Control Panel

The touch button control panel located on the top side of the AVerVision300p provides quick access to commonly used functions.

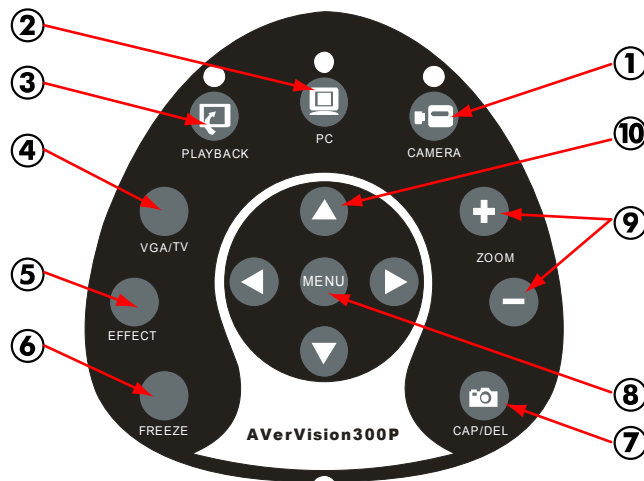

Function	Description
(1) CAMERA MODE	Switch to Camera mode and display the image from the AVerVision300p's built-in CMOS camera.
(2) PC MODE	Switch to PC mode and display the video signal from the RGB input port.
(3) PLAYBACK MODE	Switch to Playback mode and toggle to display 80-thumbnail images.
(4) VGA/TV	Switches between VGA (VGA Out) or TV (Composite Video/S-Video Out).
(5) EFFECT	Convert and display the video in BW, Negative or Color. (camera mode only)
(6) FREEZE	Toggle to pause or resume the camera.
(7) CAP/DEL	Photograph an image. The captured image is automatically stored in the memory source at 1024 x 768 resolution. AVerVision300p could save up to 80 images. In Playback Mode, press this button to delete the saved image.
(8) MENU	Call up and exit the OSD main and sub-menu.

- 
- (9) ZOOM +/- - Zoom in and zoom out the picture digitally in Playback mode.
  - Zoom in and zoom out the image optically and digitally in Camera mode. When it reaches the maximum AVERZOOM level of about 2 times, you can still continue to digitally zoom in the image up to 1600%.
- 
- (10) ▲ ▼ ◀ ▶ - Use ▲, ▼, ◀ and ▶ to make a selection and adjustment. And use ▶ to enter sub-menu. (See Menu Functions, for more details)
  - Use ▲, ▼, ◀ and ▶ to make a selection in 80-thumbnail images and press  to view the selected image.
- 

## LED Panel

The LED on the front panel of AVerVision300p indicates the status of the unit.

Color	Description
Green	The unit is operated with VGA output.
Orange	The unit is operated with TV output
Red	The unit is in standby mode.

## Infrared Sensor

When using the remote control, aim at the Infrared Sensor, which is located at the front panel of the AVerVision300p.

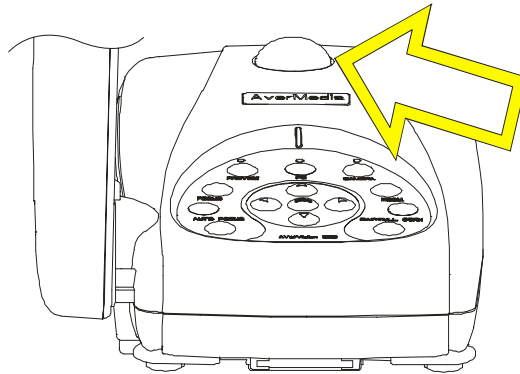

## Timer Function

The AVerVision300p enables you to control the pace of your presentation by displaying the remaining time on the countdown screen. This merely serves as a reminder. When the time is up, the timer blanks at the top right corner only and the presentation screen will not be affected in any way.

### To Set the Timer:

1. Press **MENU** to view on screen function selections.
2. Press **▲** or **▼** buttons to select **TIMER**.
3. Press **▶** or **◀** buttons to set a time value. You can set the time value up to 120 minutes.
4. After selecting a time value, press the **MENU** button to go back to the main menu.

### To View and Start the Timer Countdown:

1. To display the previously set time value, press the **TIMER** button once. The AVerVision300p automatically converts your settings to “hours:minutes:seconds” format. The maximum setting is 120 minutes.
2. To start the countdown, press the **TIMER** button again.
3. Once the countdown timer starts, you can toggle the countdown screen to display and hide it by pressing the **TIMER** button.



## Using the AVerVision Application

Use the AVerVision PC Camera applications provided to control the AVerVision300p to save any captured images or video clips to your PC, or send them via emails.

Note:

1. When a USB cable is connected between the document camera and the PC, the document camera features are controlled by the application software directly instead on the remote control.
2. If AVerVision300p is used in PC Camera mode, the frame rate is below 12 fps.

## Installing the Software

Minimum System Requirements

- Pentium®-class processor
- Windows2000 Professional with Service Pack 2 or above, Windows XP Professional or Home, or Windows XP Tablet PC
- 32 MB of RAM (64 MB recommended)
- 60 MB of available hard-disk space

To install PC Webcam Applications:

1. Insert your Software CD into your CD-ROM drive, and click on "PC Camera Applications" and follow the instructions.



2. Click "Finish" to complete installation.
3. After the installation, connect the USB cable between the AVerVision300p and your PC. Open the applications by clicking "VisionAP" icon on your desktop.

# Application User Interface

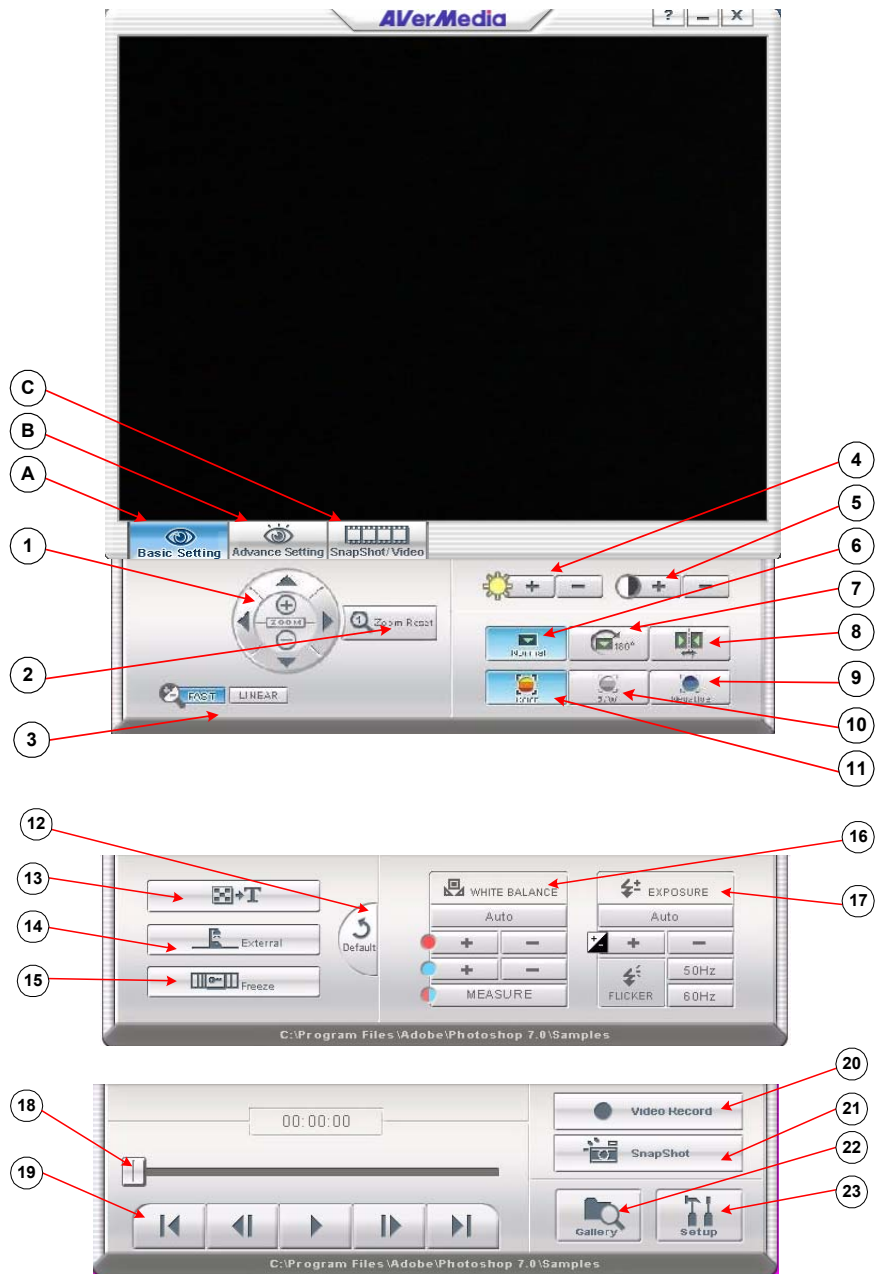



<b>A. Basic Setting</b>	
<b>Function</b>	<b>Description</b>
1	Digital Zoom and Pan Control
2	Return to normal view (1X )
3	Linear/Fast zoom-in selection.
4	Brightness adjustment
5	Contrast adjustment
6	Normal view without image rotate or mirror
7	Rotate the image by 180°.
8	Image mirroring
9	Convert the image to Negative
10	Convert the image to Black and White
11	Back to the original image
<b>B. Advance Setting</b>	
<b>Function</b>	<b>Description</b>
12	Restore to original factory setting
13	Select between text and graphic image enhancement mode
14	Display the image from AVerVision's camera or from the PC IN port
15	Freeze image
16	Adjust White Balance
17	Adjust Exposure
<b>C. SnapShot/Video</b>	
<b>Function</b>	<b>Description</b>
18	Control the video display by controlling bar
19	Play and control the video display
20	Record the video and save it into PC
21	Capture a single picture and save it into PC
22	Retrieve saved pictures or video clips
23	Setup for the picture snapshot or video recording.

## **Image Download from AVerVision300p to PC**

To download captured still images from the AVerVision300p to PC, DO NOT connect the USB cable first. Go to Menu, click on the "Advance" option, then click on the "USB Select" option, and choose "IMG Download". Next, connect the USB cable between the AVerVision300p and PC. When a dialog box appears, you are ready to download the images to your PC.

When you are finished downloading images to your PC and want to continue using the AVerVision300p in document camera mode, simply unplug the USB cable.



If you prefer to use the AVerVision300p with the PC Cam applications after image download, go to Menu, again click on the "Advance" option, then click on "USB Select" and choose the "PC Camera" option. Connect the USB cable between the AVerVision300p and the PC, and then open the VisionAP applications.

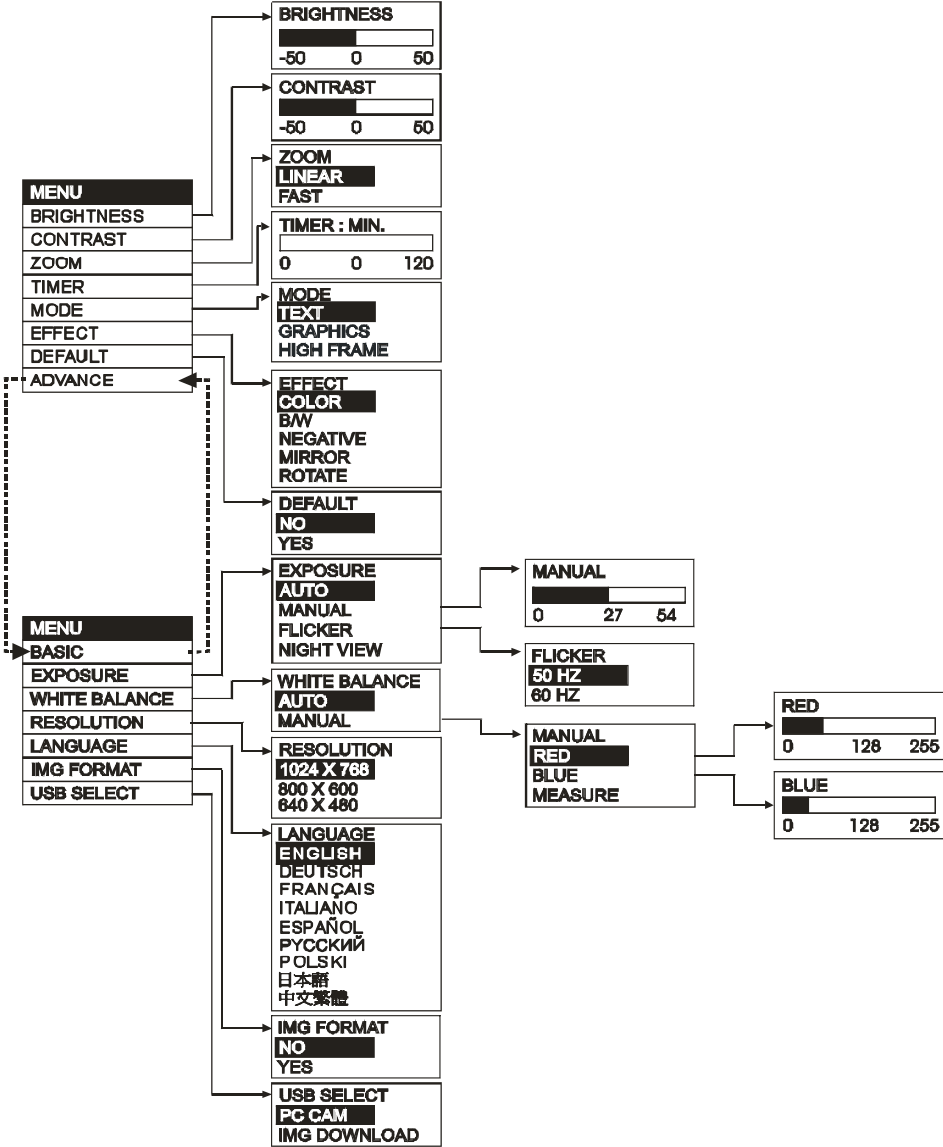



# OSD Navigation Tree

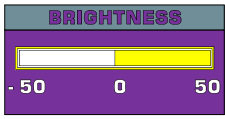
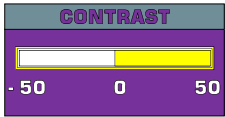

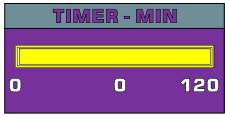
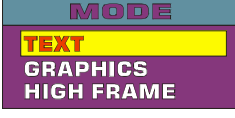

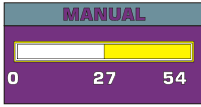
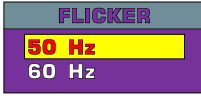

## Menu Functions

The MENU functions of the AVerVision300p enable you to fine-tune your screen display, set the timer, select OSD language and more. Press the **MENU** button to call up and exit from the main menu or sub-menu display. Use the **▲** or **▼** buttons to select the items in the menu list. Use the **▶** button to enter sub-menu. To adjust the setting, press **◀** or **▶** buttons.

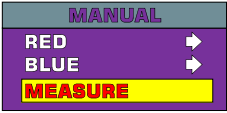
Main Menu	Sub-Menu OSD	Description
<b>BRIGHTNESS</b>		Press <b>▶</b> or <b>◀</b> buttons to increase or decrease the brightness level and improve the visibility of the image. You can adjust the brightness level up to $\pm 50$ .
<b>CONTRAST</b>		Press <b>▶</b> or <b>◀</b> buttons to emphasize or reduce the difference between light and dark conditions. You can adjust the contrast level up to $\pm 50$ .
<b>ZOOM</b>		Use <b>▲</b> or <b>▼</b> buttons to select between linear or fast zoom then press <b>▶</b> to make the selection.  Using the linear zoom you can increase or decrease the zoom values by 10%. While using the fast zoom, the increments are by 100%. The maximum amount of zoom that you can view is 1600%.
<b>TIMER</b>		Press <b>▶</b> or <b>◀</b> buttons to set a time value. You can set the time value up to 120 minutes. (Refer to the section, <i>Timer Function</i> , for more details.)
<b>MODE</b>		Use <b>▲</b> or <b>▼</b> buttons to select between Text, Graphics and High Frame modes.  In text mode, the AVerVision300p corrects the intensity of the adjacent pixel making it more uniform producing sharper and clearer images. While in graphics mode, the AVerVision300p adjusts the gradient of the adjacent pixel making it appears to have a smooth image. While in real-time requirement, we suggest to select High Frame mode, which can more visually track animated objects and react quickly. (This

Main Menu	Sub-Menu OSD	Description
		mode is better to be used in good light.)
EFFECT		Use ▲ or ▼ buttons to display the image captured by the camera into negative, positive (true color), monochrome (black and white), mirrored image, or as a rotated image by 180°.
DEFAULT		Use ▲ or ▼ buttons to select YES to restore to original factory default setting or NO to exit. Press ► to make the selection.
EXPOSURE	 	<p>Use ▲ or ▼ buttons to select between Auto and Manual.</p> <p>AVerVision300p enables you to automatically or manually adjust the camera to determine how much light is required.</p> <p>If you choose to manually adjust the exposure, press ► or ◀ buttons to adjust the exposure level.</p> <p>If you are presenting in a low-light condition, Night View enables the image of the object to appear as though under normal lighting conditions. The AVerVision300p automatically adjusts the exposure to compensate for the adverse condition, but the captured image will appear to be in slow motion.</p>
		Use ▲ or ▼ buttons to select between 50Hz or 60Hz. Some display devices cannot handle high refresh rates. The image will flicker a couple of times as the output is switched to another refresh rate.
WHITE BALANCE		<p>Use ▲ or ▼ buttons to select between Auto and Manual.</p> <p>AVerVision300p enables you to automatically or manually adjust the camera to suit the lighting condition or color temperature. If you select to manually adjust the white balance, you can adjust the Red, Blue or use the system to measure the color temperature.</p>

<b>Main Menu</b>	<b>Sub-Menu OSD</b>	<b>Description</b>
<b>WHITE BALANCE</b>		<p>To obtain a more accurate color balance, place a sheet of white paper under the camera.</p> <p>Select <b>MEASURE</b> then press ► button to calibrate the color temperature. Wait until a "<b>MEASURE OK</b>" appears at the lower left corner of the presentation screen.</p>
<b>RESOLUTION</b>		<p>Use ▲ or ▼ buttons to choose from 1024x768, 800x600 or 640x480 display resolution then press ► to make the selection.</p>
<b>LANGUAGE</b>		<p>Use ▲ or ▼ buttons to select from nine different languages then press ► to make the selection.</p>
<b>IMG FORMAT</b>		<p>Use ▲ or ▼ buttons to select No to exit or YES to format and delete all the images saved in the built-in memory then press ►.</p> <p>Please wait till the message "FORMAT" disappear to finish the process.</p>
<b>USB SELECT</b>		<p>Use ▲ or ▼ buttons to select USB functions between PC Camera and Image Download.</p> <p>In PC Camera mode, you can connect a USB cable to your computer and access the software application from the Driver CD.</p> <p>In Image Download mode, you can download the saved images from AVerVision300p's built-in memory to your computer.</p>

## Troubleshooting

This section provides many useful tips on how to solve common problems while using the AVerVision300p.

### **There is no picture on the presentation screen.**

1. Check all the connectors again as shown in this manual.
2. Check the on/off switch of the display output device.
3. Verify the setting of the display output device.
4. If you are presenting from a notebook or computer through the display output device, please check and switch the document camera source to PC Mode.

### **I have set up the AVerVision300p and checked all the connections as specified in the manual, but I cannot get a picture on the preferred presentation screen.**

1. Once the power cords are connected, the LED light turns RED as standby mode. Simply switch the AVerVision300p "ON" by pressing the on/off switch until the LED light is blanking and turns GREEN.
2. The default camera display resolution setting is on 1024x768. If your output device does not support this resolution; no image can be projected. Simply press the MENU and RIGHT or LEFT button to the increase or decrease the resolution setting.
3. If your display output device is TV or any analog device, please click on the VGA/TV button to switch output mode.

### **The picture on the presentation screen is distorted or the image is blurry.**

1. Reset all changed settings, if any, to the original manufacturer default setting (Refer to the Menu Functions for more details and steps).
2. Use the Brightness and Contrast menu functions to reduce the distortion if applicable.
3. If you discover that the image is blurry or out of focus, adjust the focus ring on the camera head.

### **There is no computer signal on presentation screen.**

1. Check all the cable connections among the display device, AVerVision300p and your PC.
2. Connect your PC to the AVerVision300p first before you power on your computer.

### **The presentation screen does not show the exact desktop image on my PC or Notebook after I toggle from Doc Cam mode to PC mode.**

1. Return to your PC or Notebook, place the mouse on the desktop and right click, choose "Properties", choose "Setting" tab, click on "2" monitor and check

the box "Extend my Windows desktop onto this monitor". Then go back one more time to your PC or Notebook and place the mouse on the desktop and right click again. This time choose "Graphics Options", then "Output To", then "Intel® Dual Display Clone", and then choose "Monitor + Notebook". After you follow these steps, you should be able to see the same desktop image on your PC or Notebook as well as on the presentation screen.

**How do I download images from AVerVision300p to PC ? Is it normal that AVerVision300p will reset to camera mode after I download images and disconnect the USB cable?**

1. Choose "IMG Download" from the Menu, and then connect the USB cable to download the captured and stored images from the AVerVision300p to your PC. When finished, unplug the USB cable. The AVerVision300p will automatically reset at camera mode.

**I have been adjusting the focus wheel and still not getting a clear image.** Detach the LED light module, turn the camera lens underneath and check if the focus ring turns the same time. If the focus ring does not turn in the beginning, continue to turn the camera lens until the focus ring turns. Once the focus ring starts turning, you may adjust the focal point again.



## **Limited Warranty**

For a period of time beginning on the date of purchase of the applicable product and extending as set forth in Section 6 of this Limited Warranty (the "Warranty Period"), AVerMedia Technologies, Inc. ("AVerMedia") warrants that the applicable product ("Product") substantially conforms to AVerMedia's documentation for the product and that its manufacture and components are free of defects in material and workmanship under normal use. "You" as used in this agreement means you individually or the business entity on whose behalf you use or install the product, as applicable. This limited warranty extends only to You as the original purchaser. Except for the foregoing, the Product is provided "AS IS." In no event does AVerMedia warrant that You will be able to operate the Product without problems or interruptions, or that the Product is suitable for your purposes. Your exclusive remedy and the entire liability of AVerMedia under this paragraph shall be, at AVerMedia's option, the repair or replacement of the Product with the same or a comparable product. This warranty does not apply to (a) any Product on which the serial number has been defaced, modified, or removed, or (b) cartons, cases, batteries, cabinets, tapes, or accessories used with this product. This warranty does not apply to any Product that has suffered damage, deterioration or malfunction due to (a) accident, abuse, misuse, neglect, fire, water, lightning, or other acts of nature, commercial or industrial use, unauthorized product modification or failure to follow instructions included with the Product, (b) misapplication of service by someone other than the manufacturer's representative, (c) any shipment damages (such claims must be made with the carrier), or (d) any other causes that do not relate to a Product defect. The Warranty Period of any repaired or replaced Product shall be the longer of (a) the original Warranty Period or (b) thirty (30) days from the date of delivery of the repaired or replaced product.

## ***Limitations of Warranty***

AVerMedia makes no warranties to any third party. You are responsible for all claims, damages, settlements, expenses, and attorneys' fees with respect to claims made against You as a result of Your use or misuse of the Product. This warranty applies only if the Product is installed, operated, maintained, and used in accordance with AVerMedia specifications. Specifically, the warranties do not extend to any failure caused by (i) accident, unusual physical, electrical, or electromagnetic stress, neglect or misuse, (ii) fluctuations in electrical power beyond AVerMedia specifications, (iii) use of the Product with any accessories or options not furnished by AVerMedia or its authorized agents, or (iv) installation, alteration, or repair of the Product by anyone other than AVerMedia or its authorized agents.

## ***Disclaimer of Warranty***

EXCEPT AS EXPRESSLY PROVIDED OTHERWISE HEREIN AND TO THE MAXIMUM EXTENT

PERMITTED BY APPLICABLE LAW, AVERMEDIA DISCLAIMS ALL OTHER WARRANTIES WITH RESPECT TO THE PRODUCT, WHETHER EXPRESS, IMPLIED, STATUTORY OR OTHERWISE, INCLUDING WITHOUT LIMITATION, SATISFACTORY QUALITY, COURSE OF DEALING, TRADE USAGE OR PRACTICE OR THE IMPLIED WARRANTIES OF MERCHANTABILITY, FITNESS FOR A PARTICULAR PURPOSE OR NONINFRINGEMENT OF THIRD PARTY RIGHTS.

### ***Limitation of Liability***

IN NO EVENT SHALL AVERMEDIA BE LIABLE FOR INDIRECT, INCIDENTAL, SPECIAL, EXEMPLARY, PUNITIVE, OR CONSEQUENTIAL DAMAGES OF ANY NATURE INCLUDING, BUT NOT LIMITED TO, LOSS OF PROFITS, DATA, REVENUE, PRODUCTION, OR USE, BUSINESS INTERRUPTION, OR PROCUREMENT OF SUBSTITUTE GOODS OR SERVICES ARISING OUT OF OR IN CONNECTION WITH THIS LIMITED WARRANTY, OR THE USE OR PERFORMANCE OF ANY PRODUCT, WHETHER BASED ON CONTRACT OR TORT, INCLUDING NEGLIGENCE, OR ANY OTHER LEGAL THEORY, EVEN IF AVERMEDIA HAS ADVISED OF THE POSSIBILITY OF SUCH DAMAGES. AVERMEDIA'S TOTAL, AGGREGATE LIABILITY FOR DAMAGES OF ANY NATURE, REGARDLESS OF FORM OF ACTION, SHALL IN NO EVENT EXCEED THE AMOUNT PAID BY YOU TO AVERMEDIA FOR THE SPECIFIC PRODUCT UPON WHICH LIABILITY IS BASED.

### ***Governing Law and Your Rights***

This warranty gives You specific legal rights; You may also have other rights granted under state law. These rights vary from state to state.

#### **Warranty Period of AVerMedia Product Purchased:**

**AVerVision DL, 100, 100 Pro:** 1 Year Limited Parts and Labor

**AVerVision110:** 2 Year Limited Parts and Labor

**AVerVision100 series, AVerVision280 & AVerVision300:** 3 Year Limited Parts and Labor

**AVerVision330, All other AVerVision300X series & 500 series:** 5 Year Limited Parts and Labor

**All other AVerMedia Products:** 1 Year Limited Parts and Labor

**All AVerVision Accessories:** 1 Year Parts and Labor



P/N 300AAB6S  
MADE IN TAIWAN