

TPC R&D and Steps towards the Design of the ILC TPC

Ron Settles
MPI-Munich/DESY

TPC R&D Groups

Europe

*RWTH Aachen
DESY
U Hamburg
U Karlsruhe
UMM Krakow
MPI-Munich
NIKHEF
BINP Novosibirsk
LAL Orsay
IPN Orsay
U Rostock
CEA Saclay
PNPI StPetersburg*

America

*Carleton U
Cornell/Purdue
LBNL
MIT
U Montreal
U Victoria*

Asian ILC gaseous-tracking groups

*Chiba U
Hiroshima U
Minadamo SU-IIT
Kinki U
U Osaka
Saga U
Tokyo UAT
U Tokyo
NRICP Tokyo
Kogakuin U Tokyo
KEK Tsukuba
U Tsukuba*

Other USA

*MIT (LCRD)
Temple/Wayne
State (UCLC)
Yale*

Please let me know if I forgot someone!

HISTORY

1992: *First discussions on detectors in Garmisch-Partenkirchen (LC92). Silicon? Gas?*

1996-1997: *TESLA Conceptual Design Report. Large wire TPC, 0.7Mchan.*

1/2001: *TESLA Technical Design Report. Micropattern (GEM, Micromegas) as a baseline, 1.5Mchan.*

5/2001: *Kick-off of Detector R&D*

11/2001: *DESY PRC proposal. for TPC R&D (European & North American teams)*

2002: *UCLC/LCRD proposals*

2004: *After ITRP,*

WWS R&D panel

Europe

Chris Damerell (Rutherford Lab. UK)

Jean-Claude Brient (Ecole Polytechnique, France)

Wolfgang Lohmann (DESY-Zeuthen, Germany)

Asia

HongJoo Kim (Korean National U.)

Tohru Takeshita (Shinsu U., Japan)

Yasuhiro Sugimoto (KEK, Japan)

North America

Dan Peterson (Cornell U., USA)

Ray Frey (U. of Oregon, USA)

Harry Weerts (Fermilab, USA)

GOAL

To design and build an ultra-high performance

Time Projection Chamber

...as central tracker for the ILC detector, where excellent vertex, momentum and jet-energy precision are required

"Large" Detector example

- Flavor tag $\delta(\text{IP}) \sim 5\mu\text{m} \oplus \frac{10\mu\text{m} \cdot \text{GeV}/c}{p \sin^{3/2} \theta}$
- Track momentum $\delta(1/p_t) \sim 6 \times 10^{-5} \text{ GeV}/c^{-1}$
- Particle Flow $\delta E/E \sim .30 / \sqrt{E}$

Energy flow

- granularity
- hermeticity
- min. material inside calos
- calos inside 4 T coil

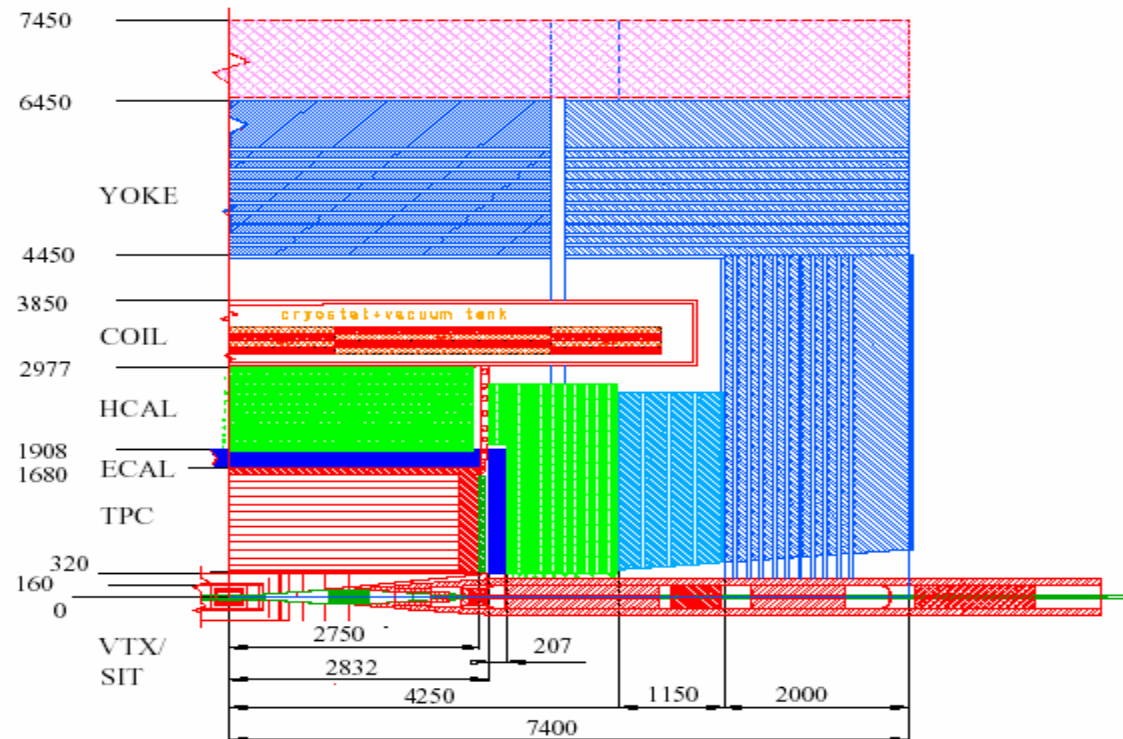

Physics determines detector design

- ★ momentum: $d(1/p) \sim 10^{-4}/\text{GeV}(\text{TPC only})$
 $\sim 0.6 \times 10^{-4}/\text{GeV}(\text{w/vertex})$
 $(1/10 \times \text{LEP})$

$e^+e^- \rightarrow ZH \rightarrow \mu\mu X$ goal: $\delta M_{\mu\mu} < 0.1 \times \Gamma_Z$
 $\rightarrow \delta M_H$ dominated by beamstrahlung

- ★ tracking efficiency: 98% (overall)

excellent and robust tracking efficiency by combining vertex detector and TPC, each with excellent tracking efficiency

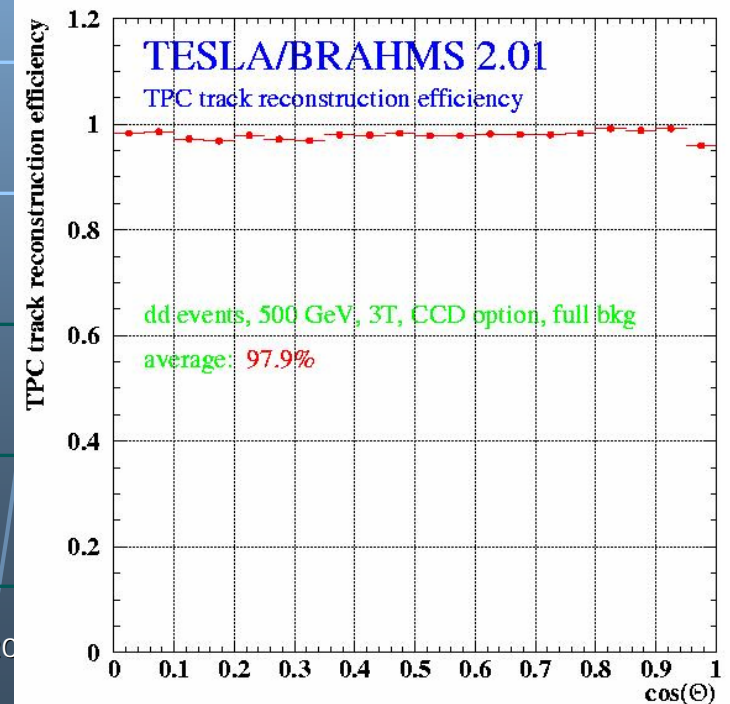
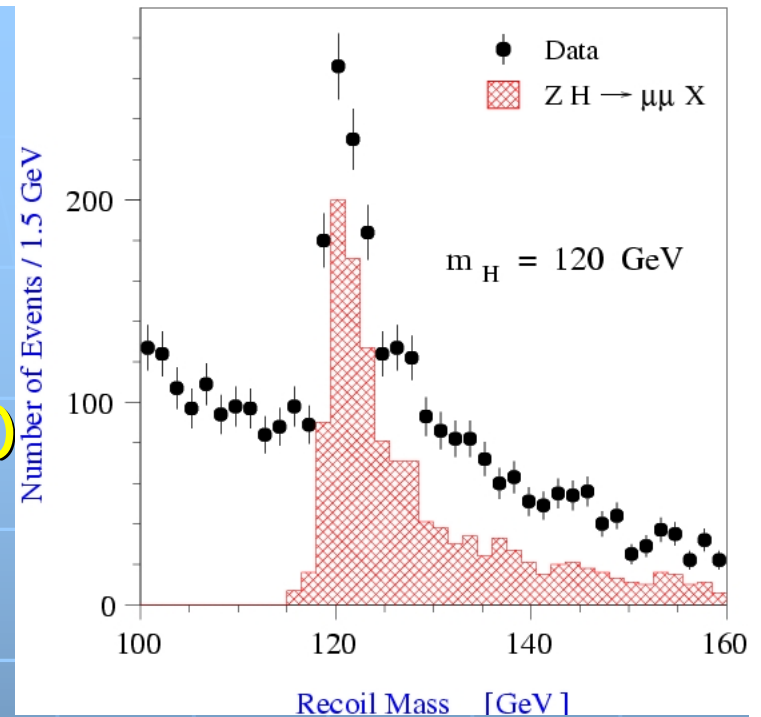

Motivation/Goals

- Continuous tracking throughout large volume
- ~98% tracking efficiency in presence of backgrounds
- Timing to 1 ns together with inner silicon layer
- Minimum of X₀ inside Ecal (<3% barrel, <30% endcaps)
- $\sigma_{pt} \sim 100\mu\text{m}$ ($r\phi$) and $\sim 500\mu\text{m}$ (rz) @ 4T for right gas if diffusion limited
- 2-track resolution <2mm ($r\phi$) and <5mm (rz)
- dE/dx resolution <5%
- Full precision/efficiency at 30 x estimated backgrounds

R&D program

- gain experience with MPGD-TPCs, compare with wires
- study charge transfer properties, minimize ion feedback
- measure performance with different B fields and gases
- find ways to achieve the desired precision
- investigate Si-readout techniques
- start electronics design for 1-2 million pads
- study design of thin field cage
- study design thin endplate: mechanics, electronics, cooling
- devise methods for robust performance in high backgrounds
- pursue software and simulation developments

OUTLINE

First, briefly,

- Gas-amplification systems
- Prototypes
- Facilities
- Examples of a few activities
 - Field cage
 - Electronics
 - Mechanics

Then, some PROTOTYPE RESULTS
(examples again) and PLANS...

Gas-Amplification Systems: Wires & MPGDs →

GEM: Two copper foils separated by kapton, multiplication takes place in holes, uses 2 or 3 stages

Micromegas: micromesh sustained by 50 μ m pillars, multiplication between anode and mesh, one stage

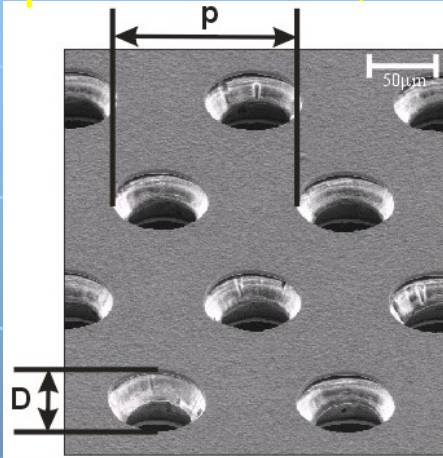

$P \sim 140 \mu\text{m}$

$D \sim 60 \mu\text{m}$

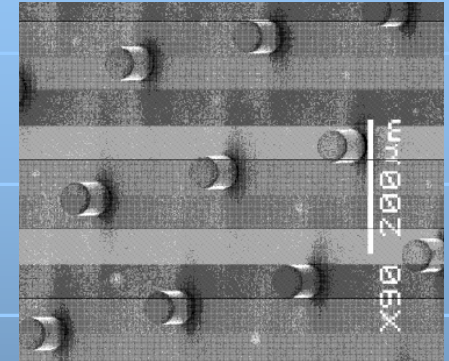
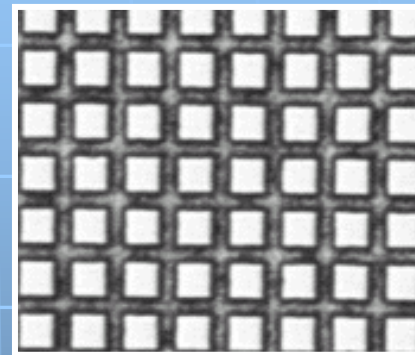

$S1/S2 \sim E_{\text{amplif}} / E_{\text{drift}}$

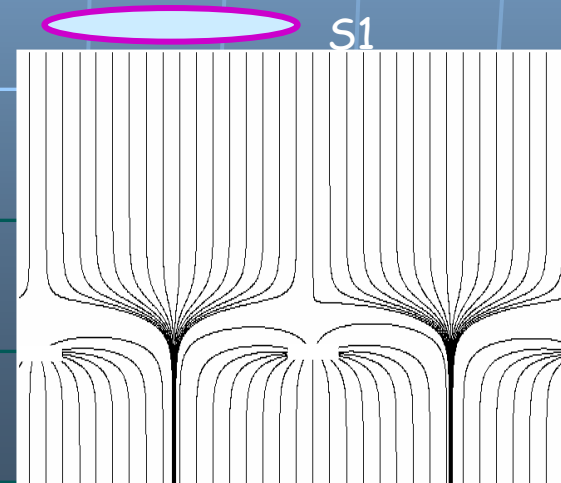
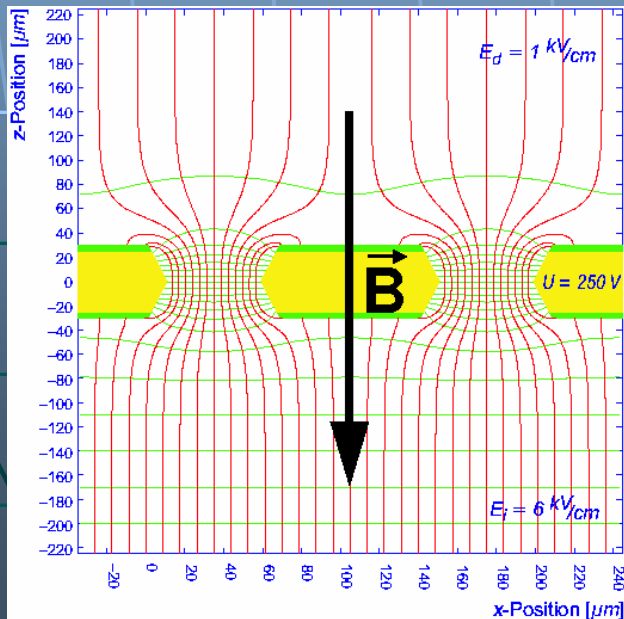

Gas-Amplification Systems: Possible manufacturers

GEM: --CERN

--Novogorod (Russia)

--Purdue + 3M (USA)

--other companies interested
in Europe, Japan and USA

Micromegas: --CERN together with

Saclay/Orsay on
techniques for
common manuf. of
anode + pillars

--Purdue/3M

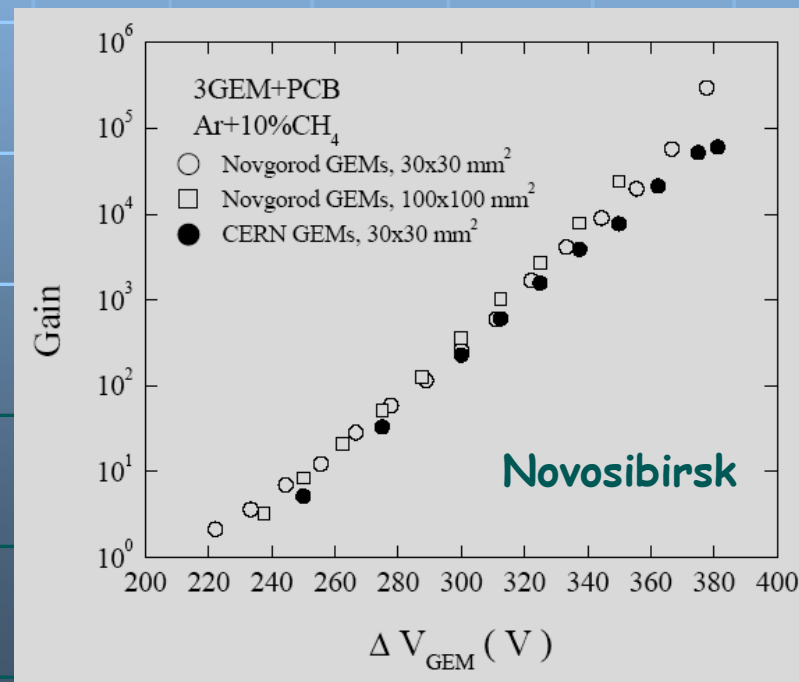

Examples of Prototype TPCs

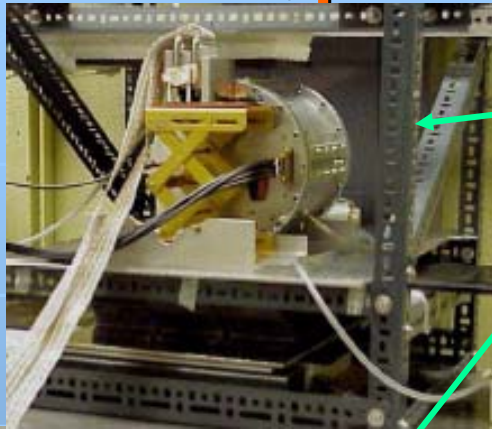

Carleton, Aachen,
Cornell/Purdue, Desy(not
shown) for B=0 studies



Desy, Victoria, Saclay
(fit in 2-5T magnets)

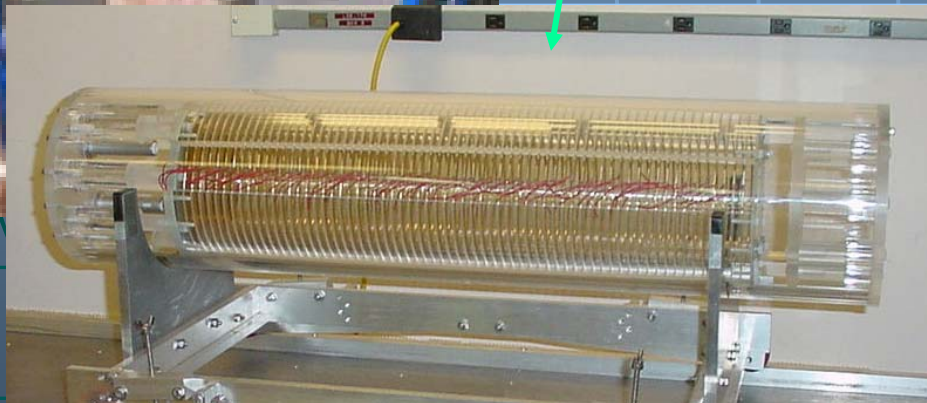

Karlsruhe, MPI/Asia,
Aachen built test TPCs
for magnets (not shown),
other groups built small
special-study chambers

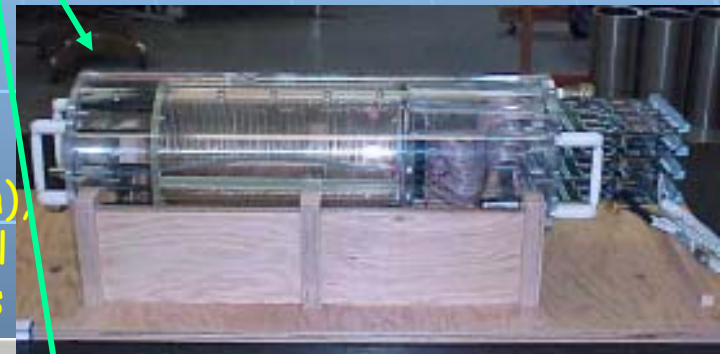
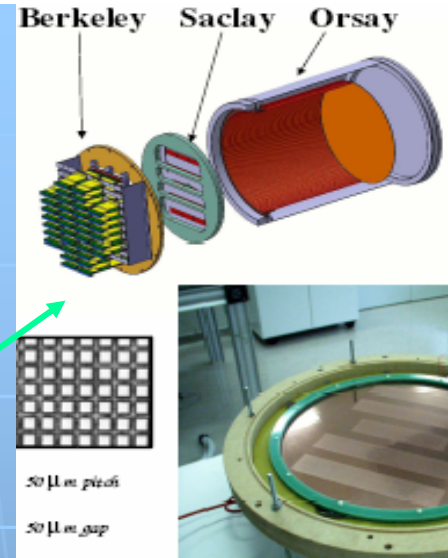

Facilities



Cern test-beam (not shown)

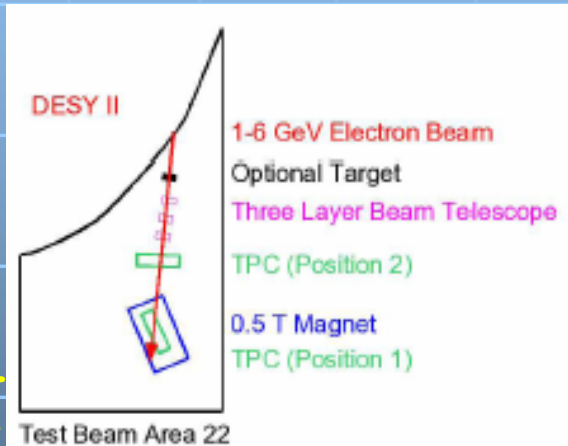

Field Cage Activities

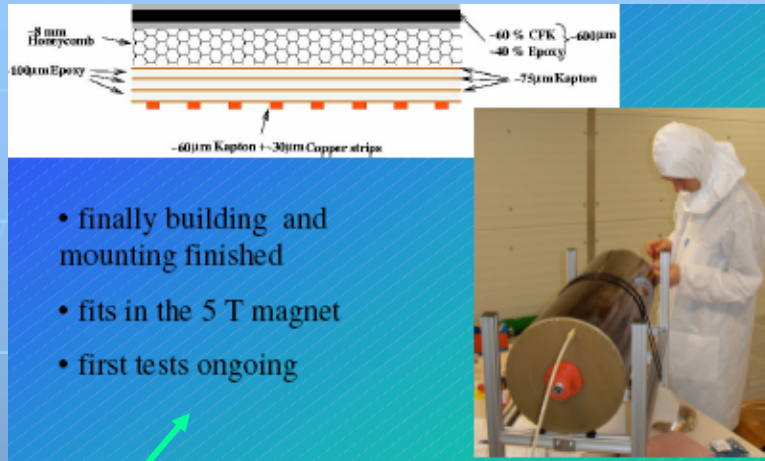

- finally building and mounting finished
- fits in the 5 T magnet
- first tests ongoing

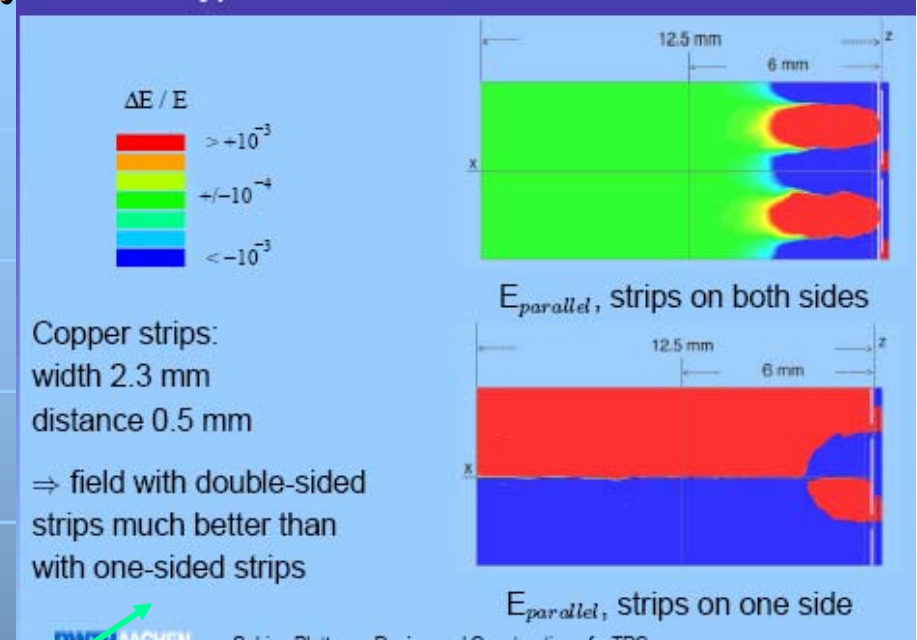

Copper strips:
width 2.3 mm
distance 0.5 mm
⇒ field with double-sided strips much better than with one-sided strips

- FC ideas tried in Desy test TPC
- Software calculations at Aachen demonstrate need for double-sided strips, test chamber built.
- St.Petersburg calculations of several FC configurations.
- Need to study Alice FC ideas.



Charge measurement with Time-to-Digit Converter

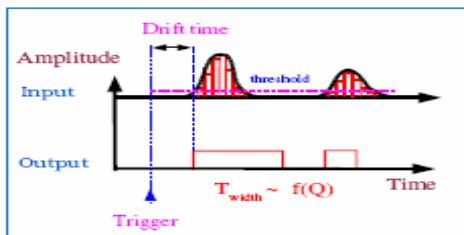

Main idea: use charge-to-time conversion technique

Readout electronics

ASDG: Amplifier-Shaper-Discriminator (charge measurement), developed for CDF's Central Outer Tracker

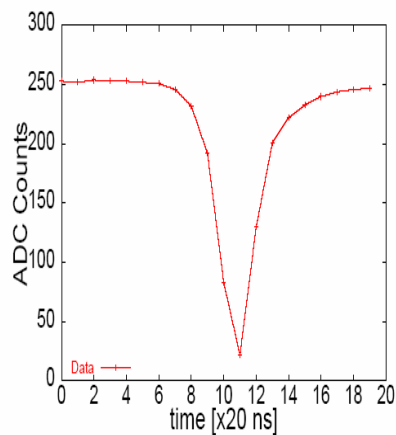
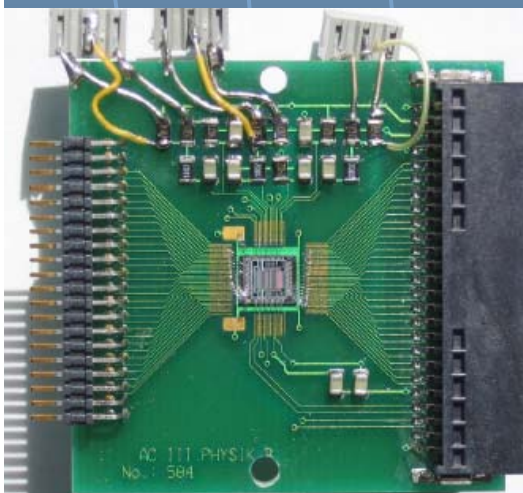
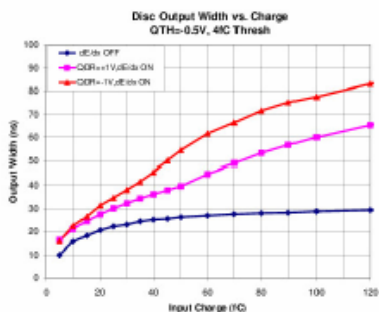

Work on Electronics

Aleph and Star setups (3 of each) used for prototype work don't take advantage of fast Gem/Mm signals from direct e-.

Rostock working on TDC idea.

Aachen studying highly integrated conventional approach.

Nikhef developing "Si RO" concepts (next slide)

Electronics Development

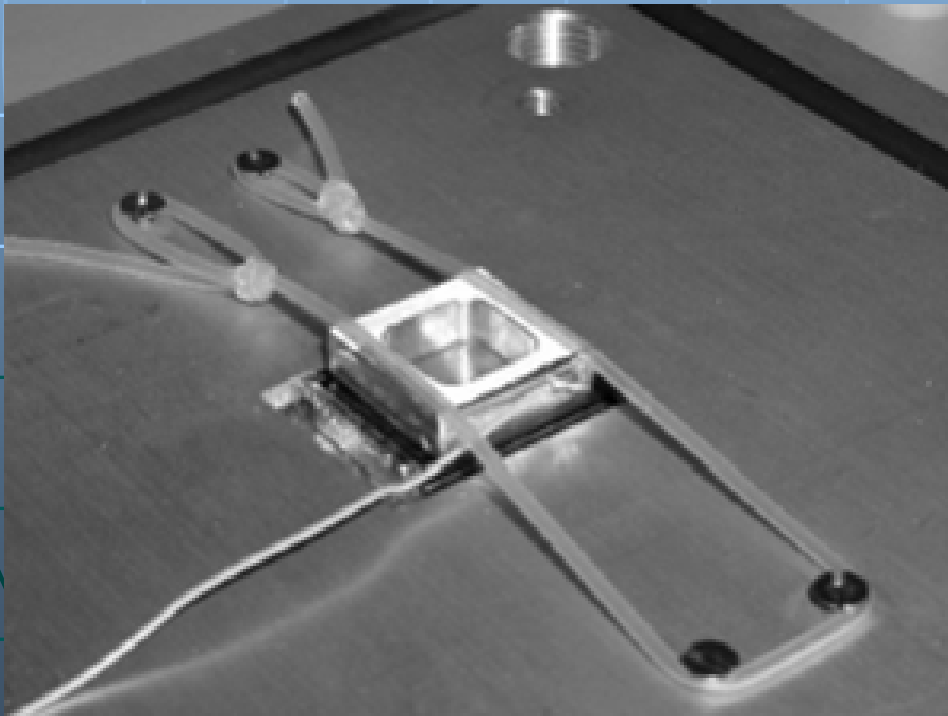
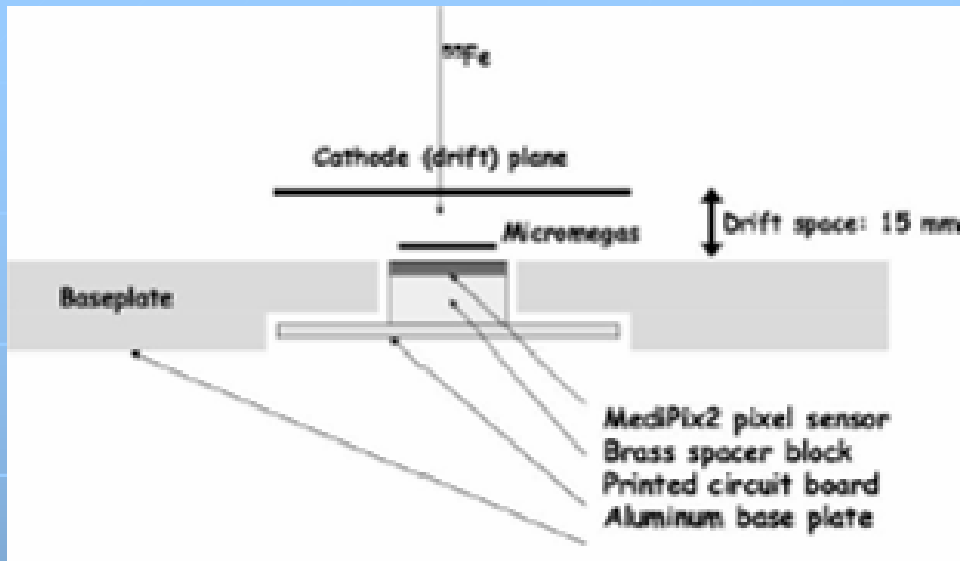

- Nikhef on CMOS readout techniques, joined by Saclay
- ~ $50 \times 50 \mu\text{m}^2$ CMOS pixel matrix + Micromegas or Gem
- ~ preamp, discr, thr.daq, 14-bit ctr, time-stamp logic / pixel
- ~ huge granularity(digital TPC), diffusion limited, sensitive to indiv. clusters for right gas
- ~ 1st tests with Micromegas + MediPix2 chip
- more later...

Work on Mechanics

Arrangements of detectors on the active area of the end cap (2/2) Trapezoidal shapes assembled in iris shape



Annotations: Px is the type number of PADS boards or frames

12 sectors (30° each) as super modules are defined
On each, 7 modules are fixed
The sizes of detectors are varying from 180 to 420 mm

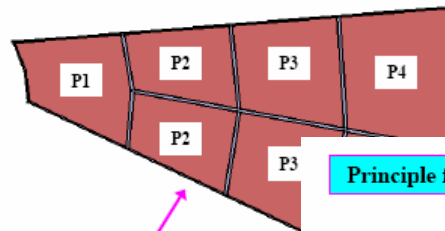
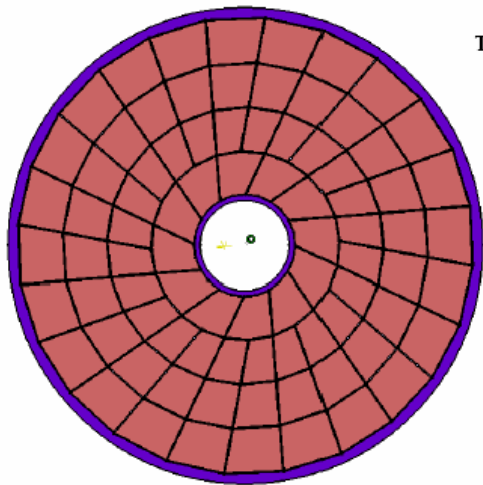

By rotation of 15° around the axis, these frames are the same

These arrangement seems to be the best as only 4 different PADS are necessary

IPN Orsay

Principle for a Super Module equipped with detector 1

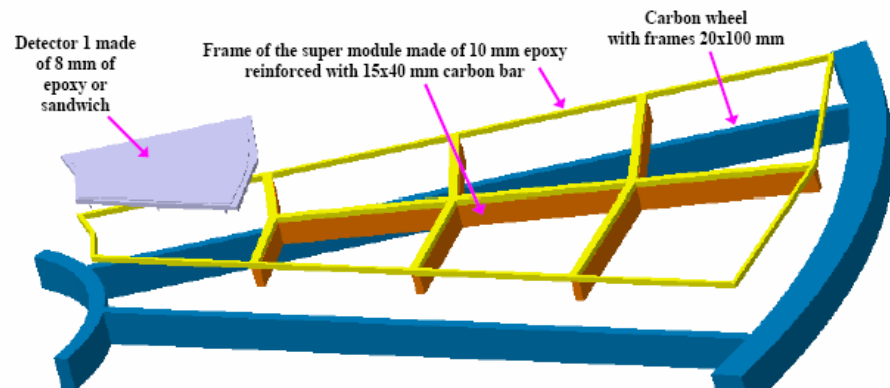

Detector 1 made of 8 mm of epoxy or sandwich

Frame of the super module made of 10 mm epoxy reinforced with 15x40 mm carbon bar

Carbon wheel with frames 20x100 mm

Deformation limit acceptability to define
Here is 20 μm / mbar of pressure

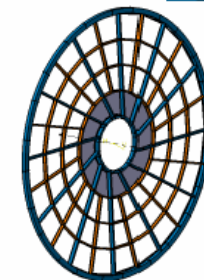
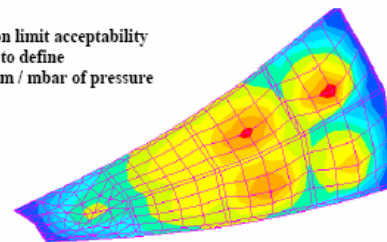

Complete wheel with 12 super modules

Simulation

- Much activity
- Simulations to understand prototype results
- Must recheck some issues now, like
 - robustness against backgrounds and
 - TPC design, overall performance
- Work in Aachen, Desy, Victoria, Kinki U...

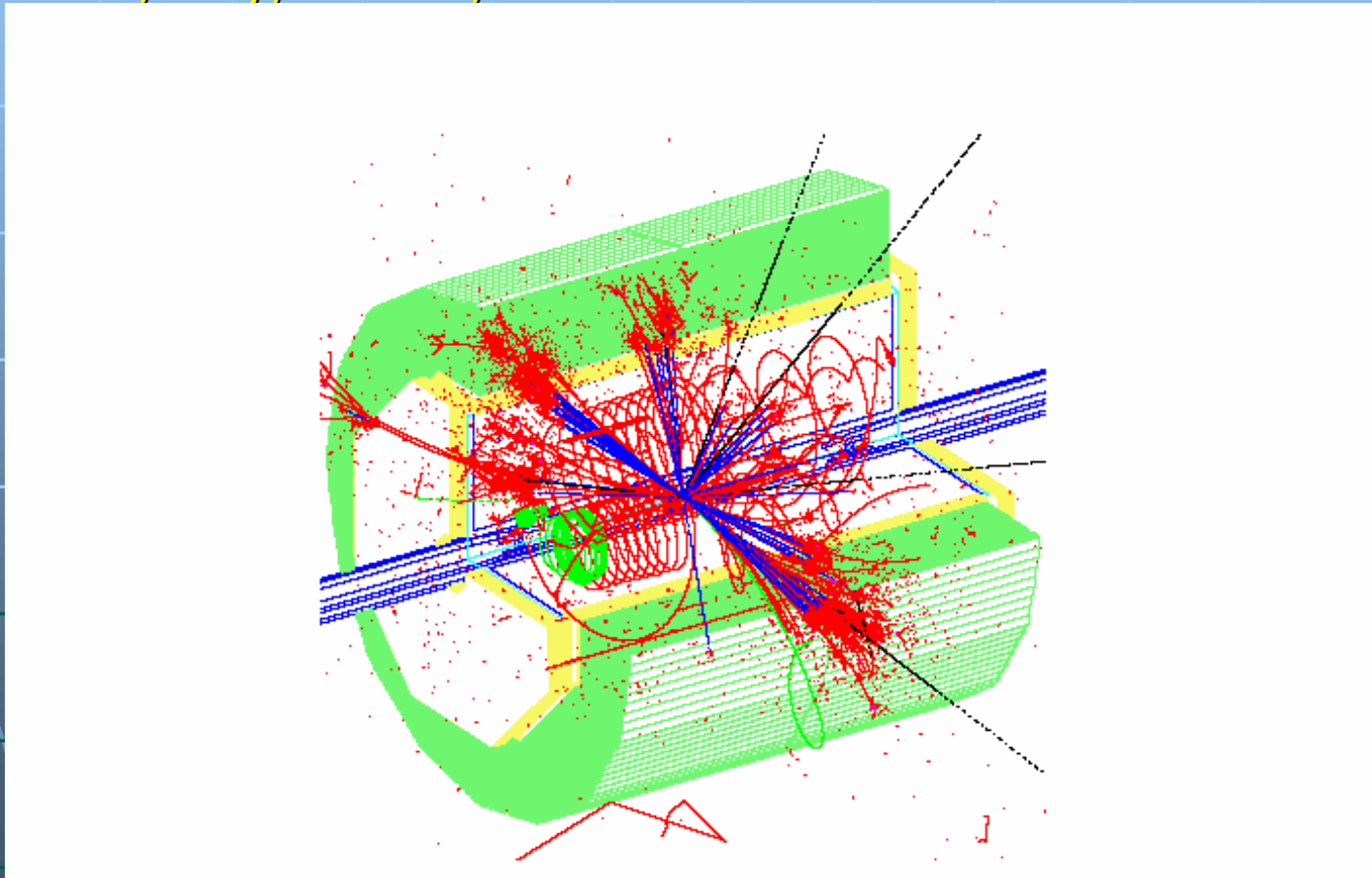

PROTOTYPE RESULTS

Presently mapping out parameter space:
demonstration phase

- Gas studies
 - Drift velocity measurements
 - Ion backdrift
 - Track distortion studies
- Point resolution
 - Two-track resolution
- Methods for improving resolution
- Results from CMOS Pixel readout
- Other activities

Prototype Results

Gas studies

- Choice of gas crucial
 - Correlated to diffusion-limited resolution
 - Drift field should not be too high
 - Drift velocity should not be too low
 - Hydrogen in quencher sensitive to neutron background
- Studied, e.g. (many done, more underway):
 - "TDR" Ar-CH4(5%)CO2(2%)
 - P5,P10 Ar-CH4(5%,10%)
 - Isobutane Ar-iC4H10(5%)
 - CF4 Ar-CF4(2-10%)
 - Helium-based
- Simulations will be useful since they have been checked (next slide)

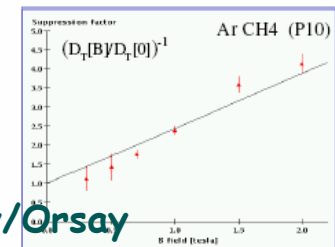
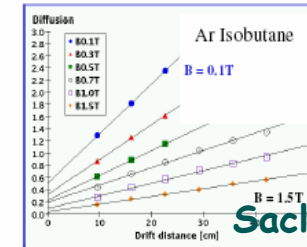
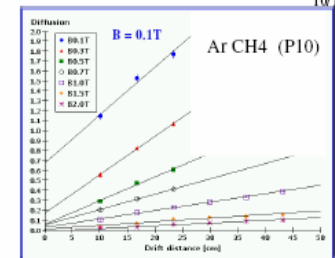
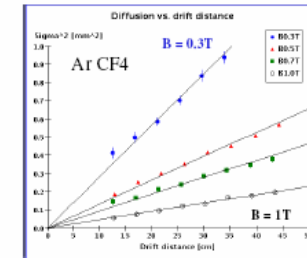

Saclay/Orsay

Prototype Results

Gas studies

Encouraging cross-checks to Magboltz simulation
Karlsruhe group (earlier by Saclay and others also):

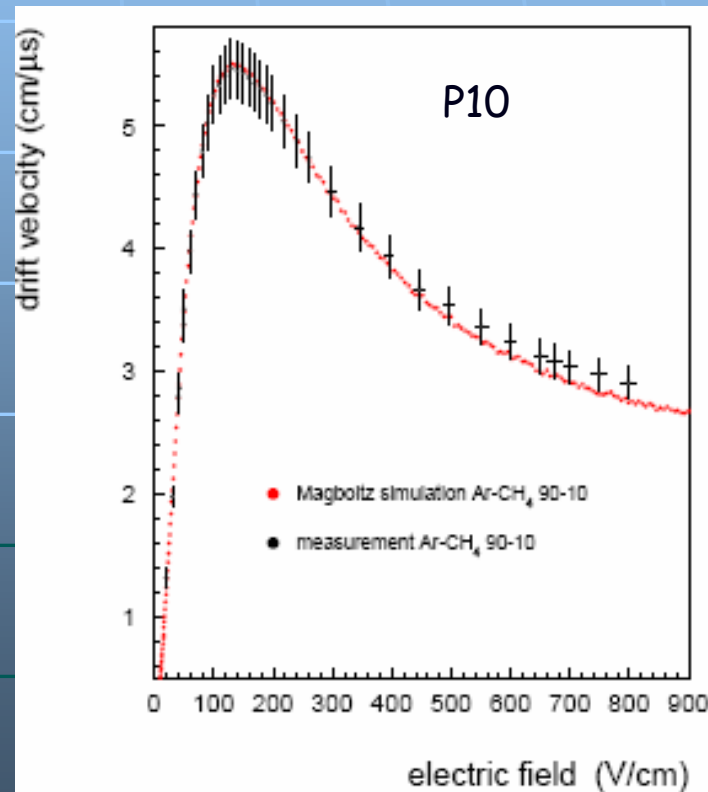
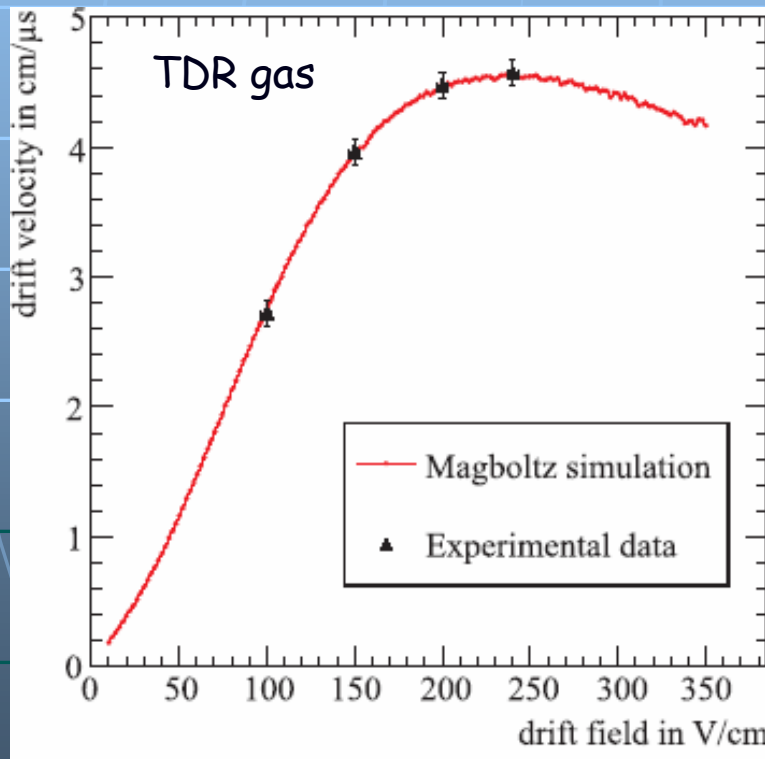

Prototype Results

Ion backdrift optimization

Aachen study for GEMs

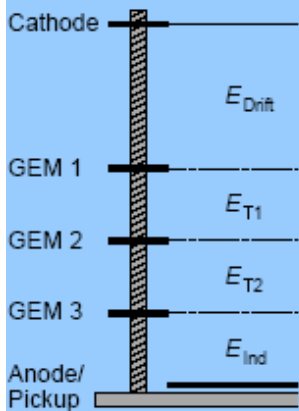

Minimal ion backdrift can be achieved with:

- E_{Drift} fixed at 240 V/cm
- U_{GEM1} small influence
- E_{T1} maximal
- U_{GEM2} small influence
- E_{T2} minimal
- U_{GEM3} maximal
- E_{Ind} maximal

U_{GEM1} and U_{GEM2} allow variation of effective gain without changing IB.

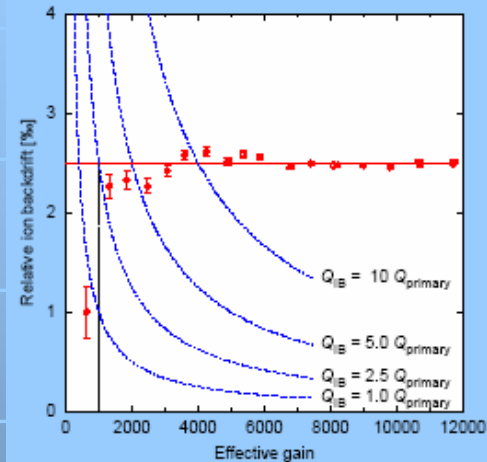

$B = 4 \text{ T}$, measured at DESY

- Prediction from parametrisation: IB independent of G_{eff}
- Lower G_{eff} yields lower backdrifting charge Q_{IB} .
- For $G_{\text{eff}} = 1000$: $Q_{\text{IB}} \approx 2.5 Q_{\text{primary}}$
- Still an open question: How much ion backdrift can be tolerated?

--With optimization, rel. ion backdrift $\sim 2.5\%$ indep. of gain

--Even with 10^5 more charge-density than expected, optimization dramatic

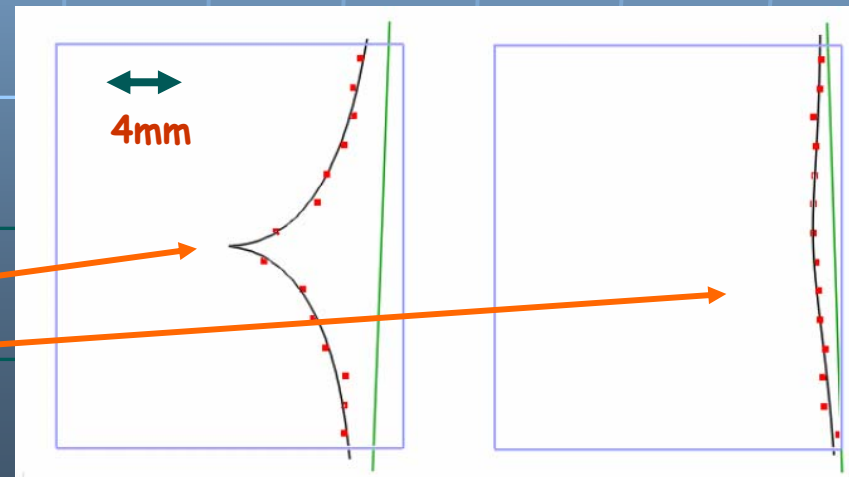

Prototype Results

Point resolution, Wires

--Measured by Asia/MPI/Desy teams in MPI wire chamber and KEK magnet at KEK test beam (1-4 GeV hadrons with PID), B=0&1T, TDR gas

--2x6mm² pads, 1mm wire-to-pad gap

--PRF width measured to be = 1.39mm

--Point resolution method: fit track with and without row in question (row#6). Geometric mean of the two results gives the correct resolution.

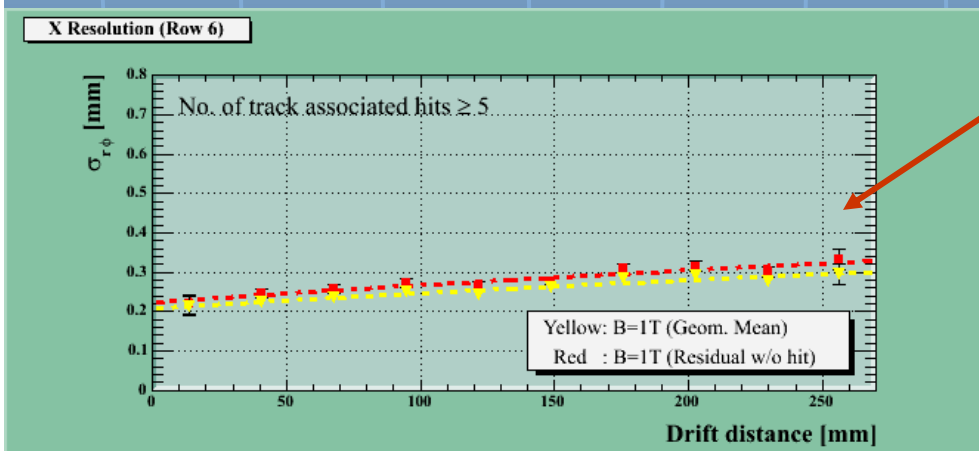
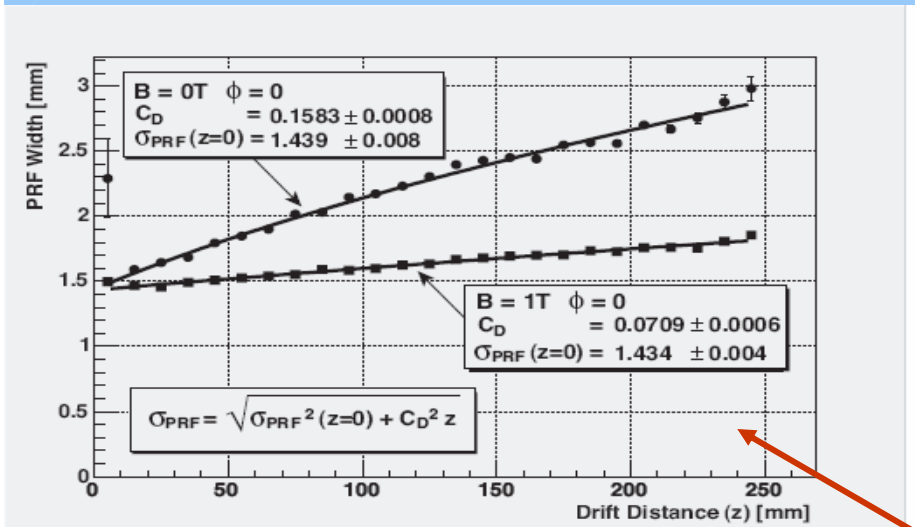

x resolution as function of B, drift distance.

Method: fit track with and without row in question (row#6). Geometric mean of the two results gives the correct resolution.

Expect ~ 170 μm resolution:

Improve S/N:

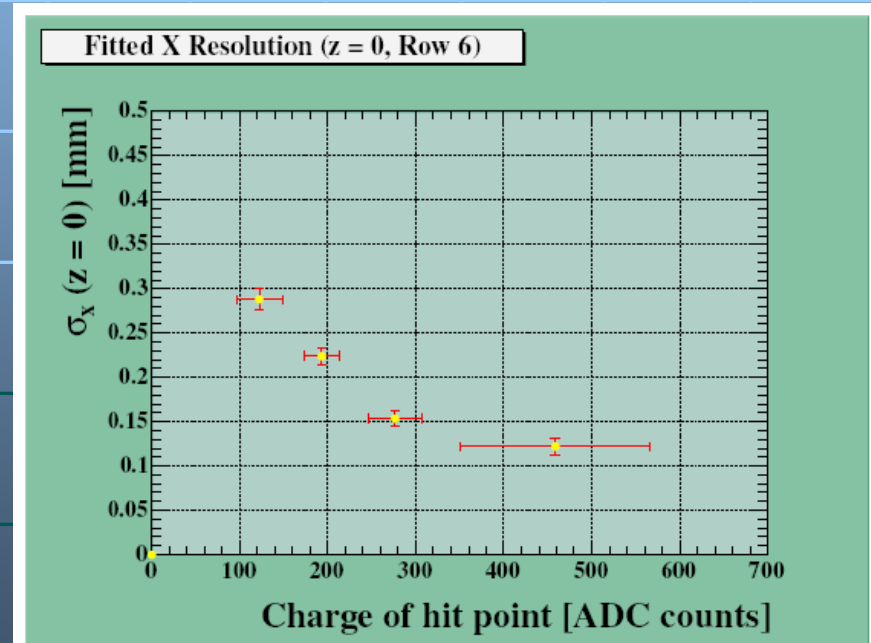
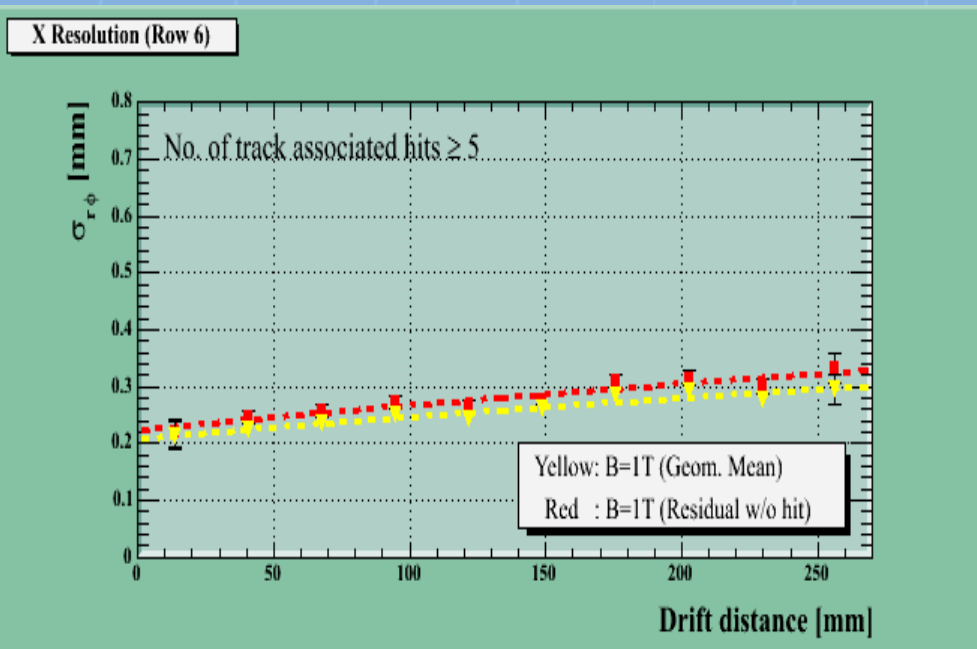

Prototype Results

dE/dx, wires, KEK beam test

dE/dx in TDR gas

7 pad-row /event × 30 events → 210 sampling

$$\sigma_{dE/dx} \sim 3.4\% \quad (-> 7.9\% \text{ w/ } 40 \text{ samples})$$

not a correct truncated mean.

good w/o calib., any corrections

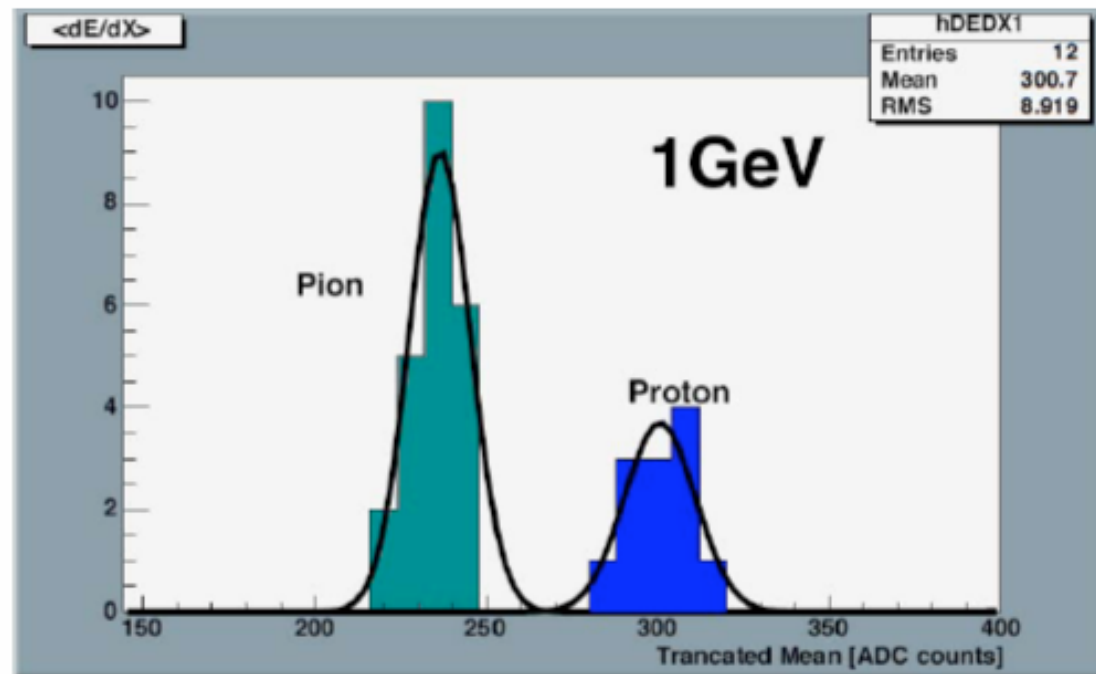

proton @1GeV/c
<dE/dx> 300.6
sigma 10.3

pi @1GeV/c
<dE/dx> 236.4
sigma 8.9

Prototype Results

Point resolution, Micromegas

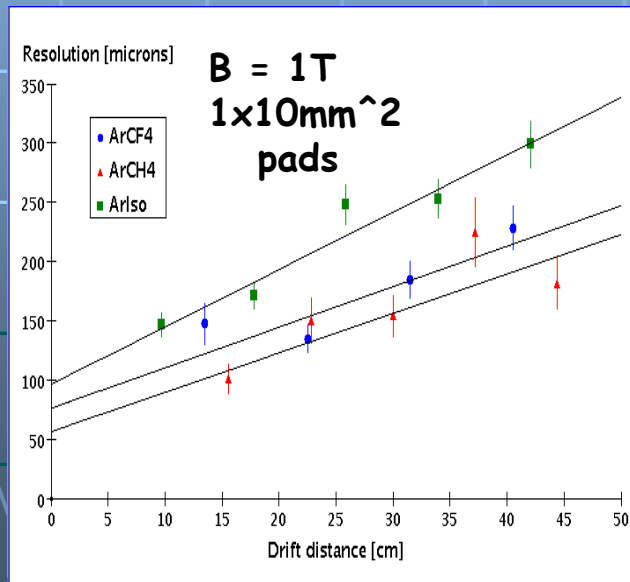
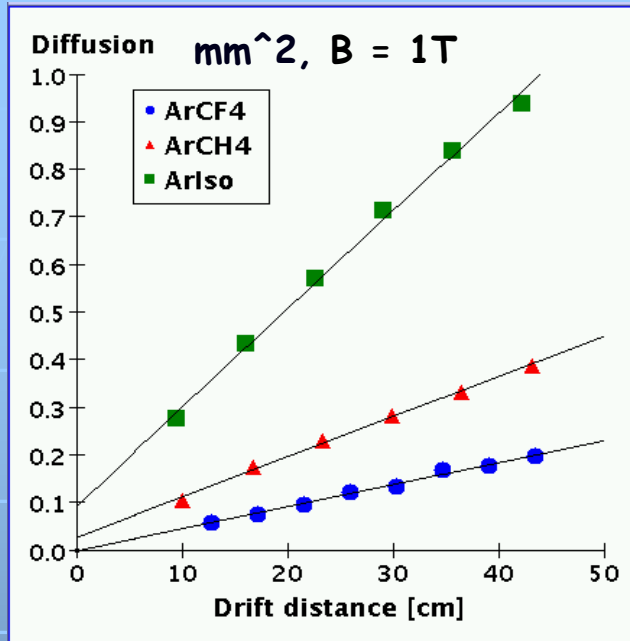

Saclay/Orsay/Berkeley

--Ageing negligible

--Diffusion measurements \Rightarrow
 $\sigma_{\text{pt}} < 100\mu\text{m}$ possible

--At moment only achieved
for short drift (intrinsic σ)
for gain ~ 5000 (350V mesh),
noise $\sim 1000e$

--Analysis continuing...

Prototype Results

Point resolution, Gem

--Two examples of σ_{pt} measured for Gems and $2 \times 6 \text{ mm}^2$ pads.

--In Desy chamber (triple Gem), resolution using "triplet method".

--In Victoria chamber (double Gem), unbiased method used: track fit twice, with and without padrow in question, σ determined for each case; geometric mean of the two σ 's gives the correct result.

--In general (also for Micromegas) the resolution is not as good as simulations expect; we are searching for why (electronics, noise, method).

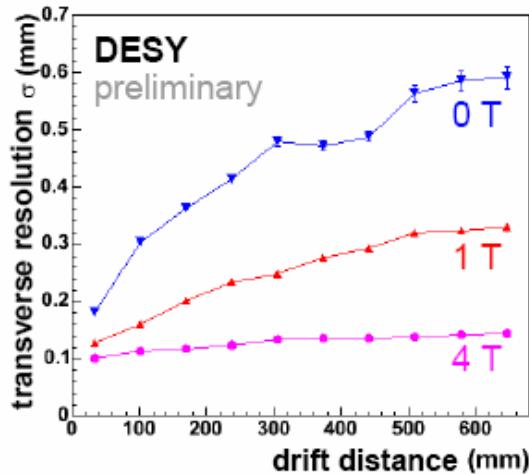

- TESLA TDR gas (Ar:CH₄:CO₂ 93:5:2)
- Non-staggered pads (2.2 x 6.2 mm²)



Resolution determined by:

- diffusion
- defocussing
- readout geometry

(relative contributions vary with B)

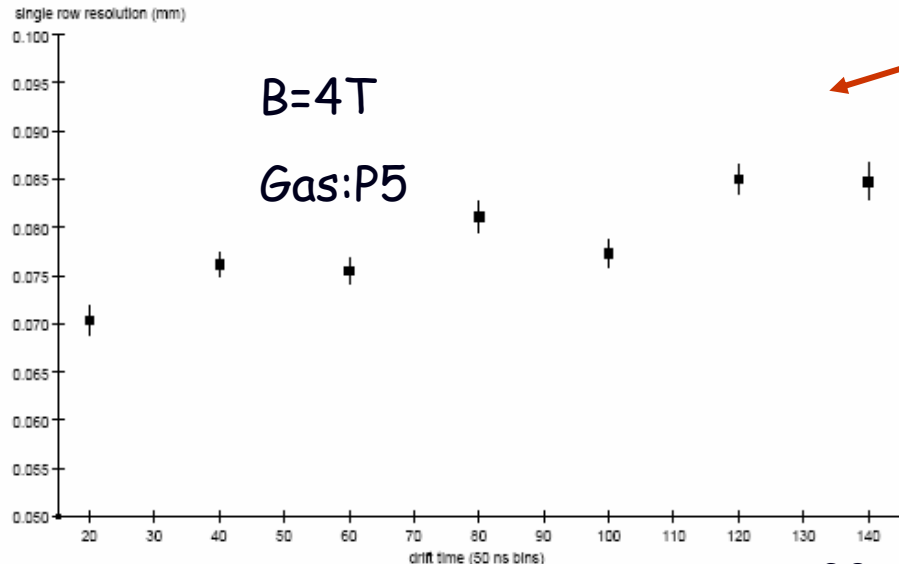

30cm

Prototype Results

Improving point resolution with resistive foil

Carleton work. Charge dispersion via resistive foil improves resolution: for $B=0$

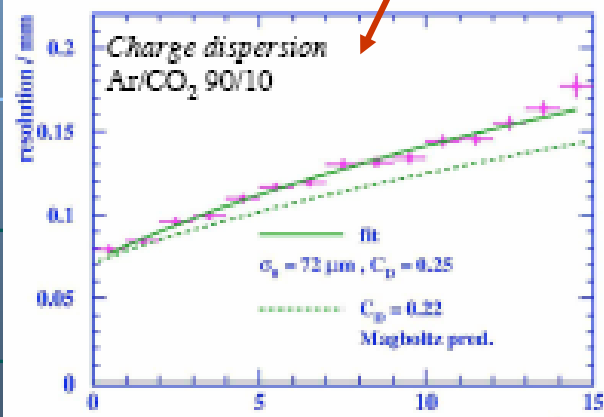
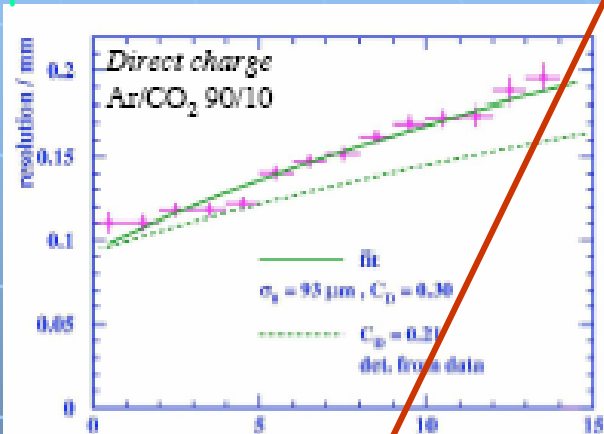
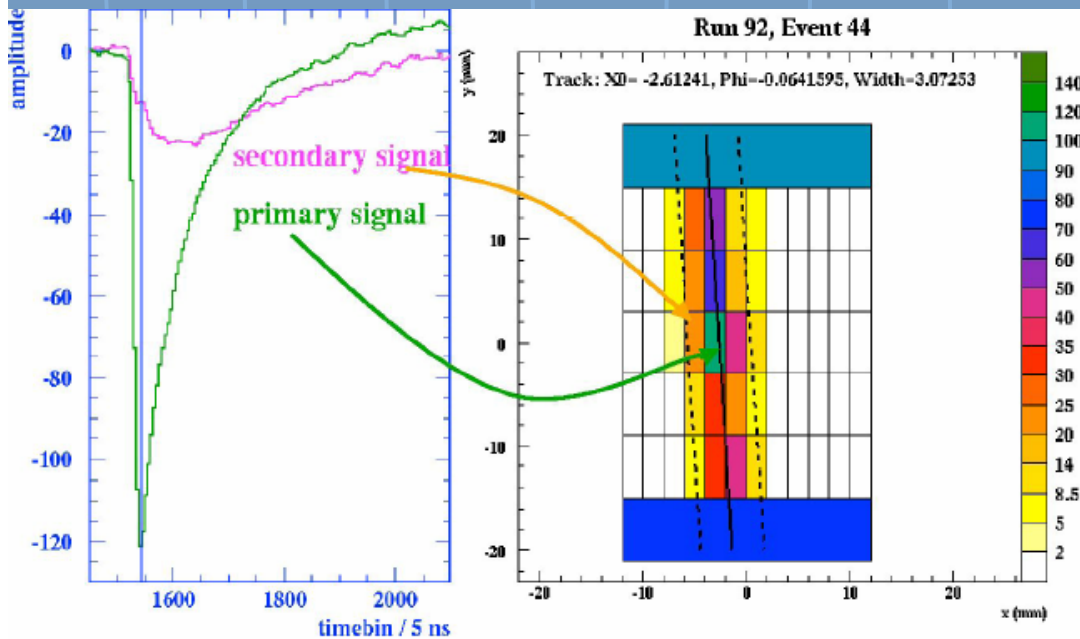
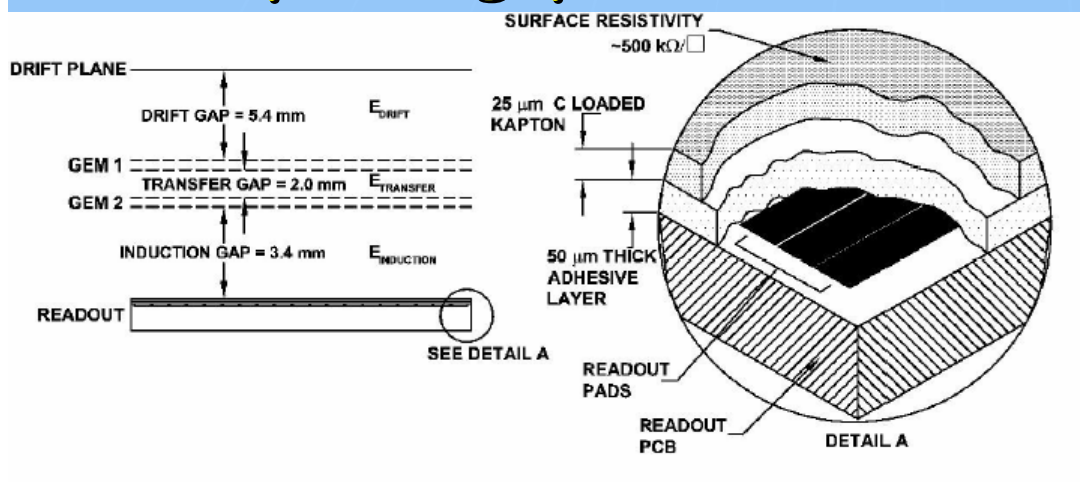

$$\sqrt{\sigma_0^2 + \frac{C_D^2}{N_e} z}$$

Medipix2+Micromegas: results

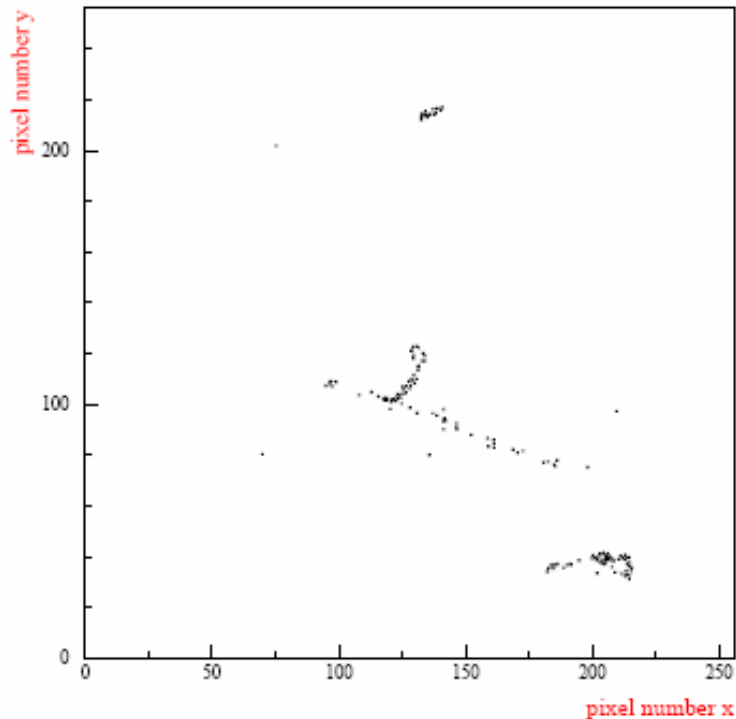

- Single-electron sensitivity demonstrated: Fe55 source, open30s/close, He/20%Isobut., threshold=3000e, gain=19K (-470V Mmegas), -1kV drift
- Measure diffusion const. $\sim 220\mu\text{m}/\sqrt{\text{cm}}$, $N_{\text{cluster}} \sim 0.52/\text{mm}$, in reasonable agreement with simulation
- Future: develop "TimePixGrid" prototype by Nikhef/Saclay/et.al. for TPC application

Prototype Results

Two-track resolution studies

Laser optics

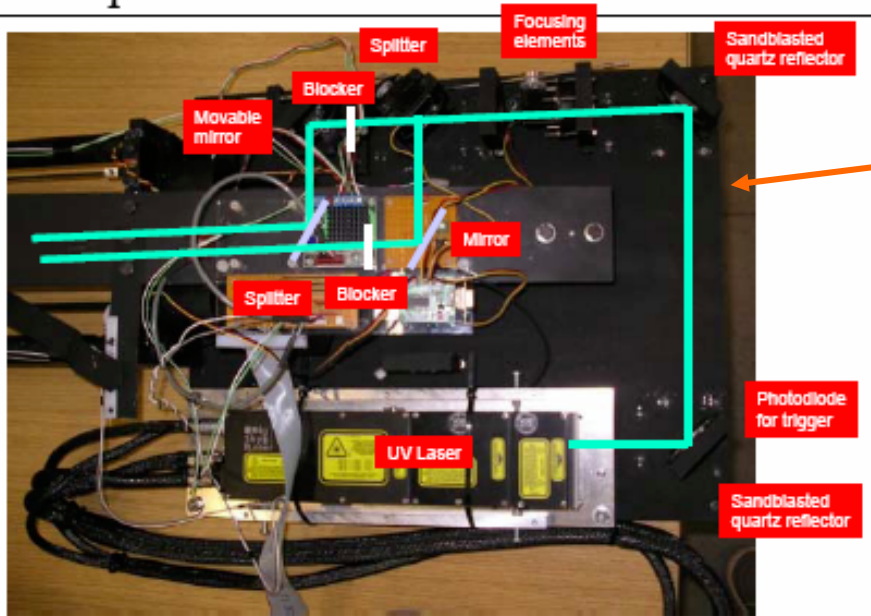

Studies just starting.

Victoria steering mechanics, Desy laser and 5T magnet.

Two track resolution at 4T

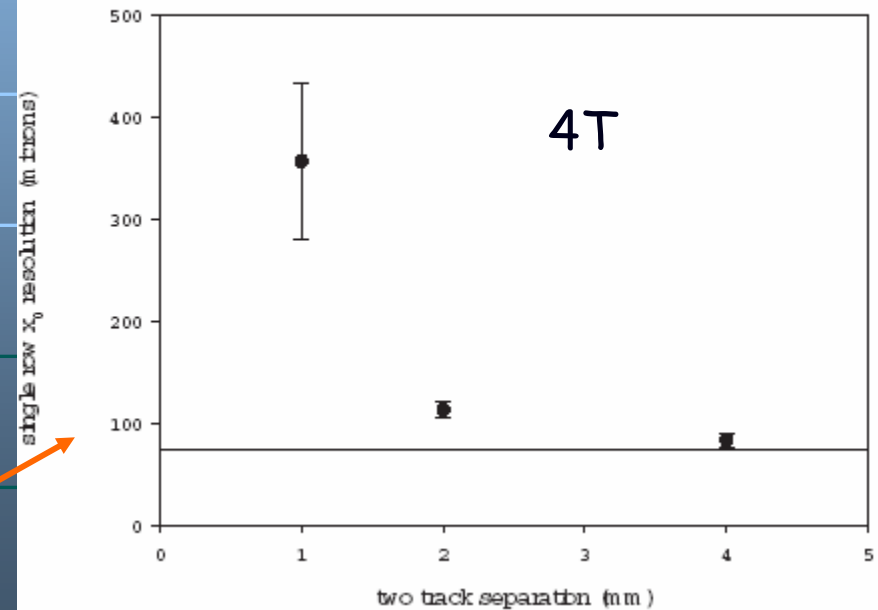

σ_{point} for cosmics \sim laser $\sim 80\mu\text{m}$
 2-track resol. for lasers $\sim 1\text{-}2\text{mm}$:
 how the resolution on one track is
 affected by presence of a nearby
 parallel track at same drift dist.

Other activities:

MIT

Lorentz-angle meas., Gas studies,
Gem resolution/manufacturing

Cornell

Simulation of pad size, resolution

Kinki U.

...ditto...

Prototype Results

Operational experience

- No systematic statistics yet
- Several groups have had problems with sparking (with both Gems and Micromegas)
- But it is too early to take this seriously (I had similar problems with Aleph)
- Needs systematic study (to avoid an msgc-type problem)...
- The "Large Prototype" will answer this.

TPC Summary (PRC, Nov04)

- Experience with *MPGDs* being gathered rapidly
- Gas properties rather well understood
- Diffusion-limited resolution seems feasible
- Resistive foil charge-spreading demonstrated
- CMOS RO demonstrated
- Design work starting

Plans

■ 1) Demonstration phase

- Continue work for ~1 year with small prototypes on mapping out parameter space, understanding resolution, etc, to prove feasibility of an MPGD TPC. For Si-based ideas this will include a basic proof-of-principle.

■ 2) Consolidation phase

- Build and operate “large” prototype ($\varnothing \geq 70\text{cm}$, drift $\geq 50\text{cm}$) which allows any MPGD technology, to test manufacturing techniques for MPGD endplates, fieldcage and electronics. Design work would start in ~1/2 year, building and testing another ~ 2 years.

■ 3) Design phase

- After phase 2, the decision as to which endplate technology to use for the LC TPC would be taken and final design started.

TPC milestones

2005	Continue testing, design large prototype
2006-2007	Test large prototype, decide technology
2008	Proposal of/final design of LC TPC
2012	Four years for construction
2013	Commission TPC alone
2014	Install/integrate in detector

Written report
for the PRC
October 2004,
where the
plans and
milesones on
the previous
two slides were
presented.

The discussion
is now in
progress...

TPC R&D for an ILC Detector

Status Report from the LC-TPC groups ^{1 2}

LC TPC groups

America

Carleton U, LBNL, MIT, U Montreal, U Victoria

*Asia*³

Chiba U, Hiroshima U, Minadamo SU-IIT, Kinki U Osaka, Saga U, Tokyo UAT, U Tokyo,
NRICP Tokyo, Kogakuin U Tokyo, KEK Tsukuba, U Tsukuba

Europe

RWTH Aachen, DESY, U Hamburg, U Karlsruhe, UMM Kraków, MPI-Munich, NIKHEF,
BINP Novosibirsk, LAL Orsay, IPN Orsay, U Rostock, CEA Saclay, PNPI StPetersburg

See next page for list of authors.

Abstract

This report gives an overview of TPC studies as of October 2004. Representative results from various groups are shown and are preliminary. The R&D issues are discussed and are illustrated with examples, for the sake of conciseness, to characterize the status of the R&D.

¹Proposal PRC R&D-01/03 of the DESY Physics Review Committee. The present status is of October 2004 and has been submitted for the DESY PRC Meeting of 28/29 October 2004.

²The WWSOC, the Organising Committee for the World-Wide Study on Physics and Detectors for the Linear Collider is forming a subcommittee for overiewing LC Detector R&D activities globally, in conjunction with America (USLCSG, NSERC-GSC), Asia (ACFA <http://ccwww.kek.jp/acfa/>) and Europe (DESY PRC).

³Working with DESY/MPI-Munich on beam tests at KEK using the MPI prototype.

Requirements on the LC TPC Design

2 A TPC for the ILC

The requirements for a TPC at the ILC are summarized in the following table.

Momentum resolution	$\delta(1/p_t) \sim 10^{-4}/\text{GeV}/c$ (TPC only; $\times 2/3$ when IP included)
Solid angle coverage	Up to at least $\cos\theta \sim 0.98$
TPC material budget	$< 0.03X_0$ to outer field cage in r $< 0.30X_0$ for readout endcaps in z
$\sigma_{\text{singlepoint}}$ in $r\phi$	$\sim 100\mu\text{m}$
$\sigma_{\text{singlepoint}}$ in rz	$\sim 0.5\text{ mm}$
2-track resolution in $r\phi$	$< 2\text{ mm}$
2-track resolution in rz	$< 5\text{ mm}$
dE/dx resolution	$< 5\%$
Performance robustness	$> 95\%$ tracking efficiency (TPC only), $> 98\%$ overall tracking
Background robustness	Full precision/efficiency in backgrounds of 10% occupancy (simulations estimate $\sim 0.3\%$)

Table 1: Typical list of performance requirements for a TPC at a ILC detector. The values are taken from one large-detector-type proposal but are similar for the different large detectors being discussed.

DESIGN OF THE LC TPC

MAIN QUESTIONS

- 1) ELECTRONICS
- 2) TECHNOLOGY
- 3) GAS

How to focus our efforts to answer these questions? One way which we are trying: collaborate to build large prototype...

First meeting at Paris LDC WS, 14 Jan '05

Second meeting at Stanford LCWS05, 21 March '05

TPC Group Leaders 21 March 2005

AGENDA



- Status
- Serpentinewindings
- Future of LC TPC R&D
- Large prototype
- Altro chip
- AOB

-Status: several grant requests

US-J, MONBUSHO GRANT-IN-AID, etc (Asia)
EUDET (Europe + associated labs)
NSERC (Canada)
DOE/NSF (US)

Serpentine/shielding windings

- Need to understand how non-uniform B field can be.
- Related to how accurate B-field must be mapped => in principle if know B infinitely precisely, can correct exactly any B-field non-uniformity. Back-of-the-envelope guess:
 $\delta B \sim 0.5 \text{ ‰}$
- Historically $\int \{B_r/B_z dz \sim 2 \text{ mm}$ for LEP, but there may be regions in the LCTPC where this gets as large as 20mm due to the serpentine windings.
- Need simulation help to set these tolerances!

Large Prototype

- In a nutshell, we are discussing the feasibility of building a large prototype to enable the
- GEM-or-MicroMegas decision, which must be timely enough to allow
- Completion of the detector at the same time as the LC -- 2015
- The large prototype should also provide input for the design of the LC TPC.
- First we need a written report to the WWS R&D committee outlining the motivation and goals for wanting the large prototype.

Large Prototype Components

- 0) Overall design; design of components
- 1) Magnet
- 2) Field cage
- 3) Endplates
- 4) Electronics
- 5) Test beam
- 6) Software
- 7) Simulation

=> Who is interested in doing what? As soon as we know, the groups for each component should get together and organize themselves

AOB

- How to organize ourselves?
Group leaders as new steering committee to expand the one set up for the PRC?
- Large prototype document for the WWS R&D committee.
- (Loose) MOU (similar to Calice) for large prototype?