

# Linear Collider Flavour Identification

P Allport<sup>3</sup>, D Bailey<sup>1</sup>, C Buttar<sup>2</sup>, D Cussans<sup>1</sup>, C J S Damerell<sup>3</sup>, J Fopma<sup>4</sup>, B Foster<sup>4</sup>, S Galagedera<sup>5</sup>,  
A R Gillman<sup>5</sup>, J Goldstein<sup>5</sup>, T J Greenshaw<sup>3</sup>, R Halsall<sup>5</sup>, B Hawes<sup>4</sup>, K Hayrapetyan<sup>3</sup>, H Heath<sup>1</sup>,  
S Hillert<sup>4</sup>, D Jackson<sup>4,5</sup>, E L Johnson<sup>5</sup>, N Kundu<sup>4</sup>, A J Lintern<sup>5</sup>, P Murray<sup>5</sup>, A Nichols<sup>5</sup>,  
A Nomerotski<sup>4</sup>, V O'Shea<sup>2</sup>, C Parkes<sup>2</sup>, C Perry<sup>4</sup>, K D Stefanov<sup>5</sup>, S L Thomas<sup>5</sup>, R Turchetta<sup>5</sup>,  
M Tyndel<sup>5</sup>, J Velthuis<sup>3</sup>, G Villani<sup>5</sup>, S Worm<sup>5</sup>, S Yang<sup>4</sup>

1. Bristol University
2. Glasgow University
3. Liverpool University
4. Oxford University
5. Rutherford Appleton Laboratory



# Linear Collider Flavour Identification: Activities

- o LCFI Outline
  - Simulation and Physics Studies
  - Sensor Development
  - Readout and Drive Electronics
  - External Electronics
  - Integration and Testing
  - Vertex Detector Mechanical Studies
  - Test-beam and EMI Studies

*→ LCFI is active in the development of the full vertex detector*

# LCFI Physics Studies

## o Identification of b/c quarks

- ZVTOP algorithm plus neural net
- Modest improvement in b tagging over that achieved at SLD.
- Improvement by factor 2 to 3 in charm tagging efficiency.
- Charm tag interesting e.g. for Higgs BR measurements.

## o Identification of quark charge

- Must assign all charged tracks to correct vertex.
- Multiple scattering critical, lowest track momenta  $\sim 1$  GeV.
- Sum charges associated with b vertex:

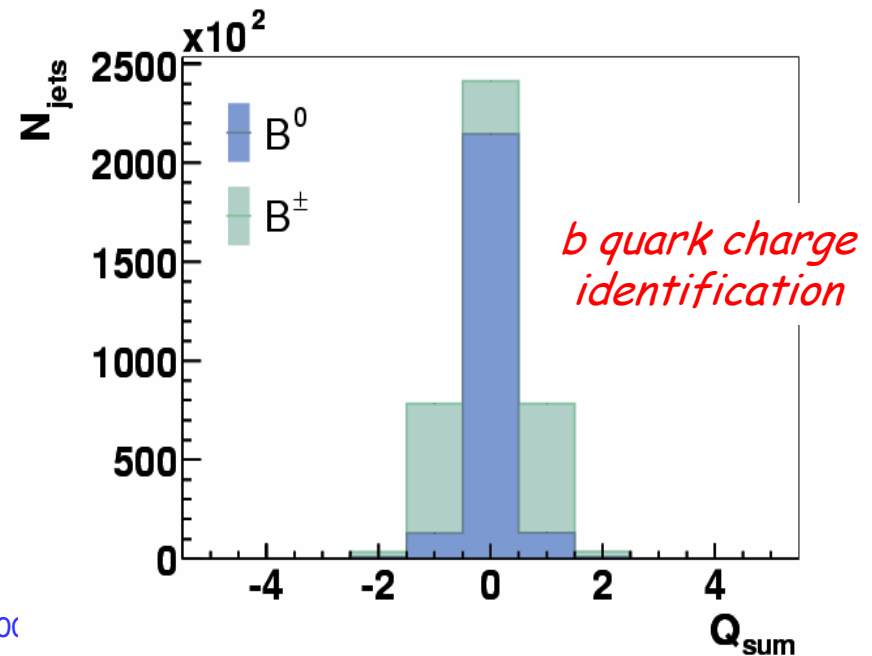
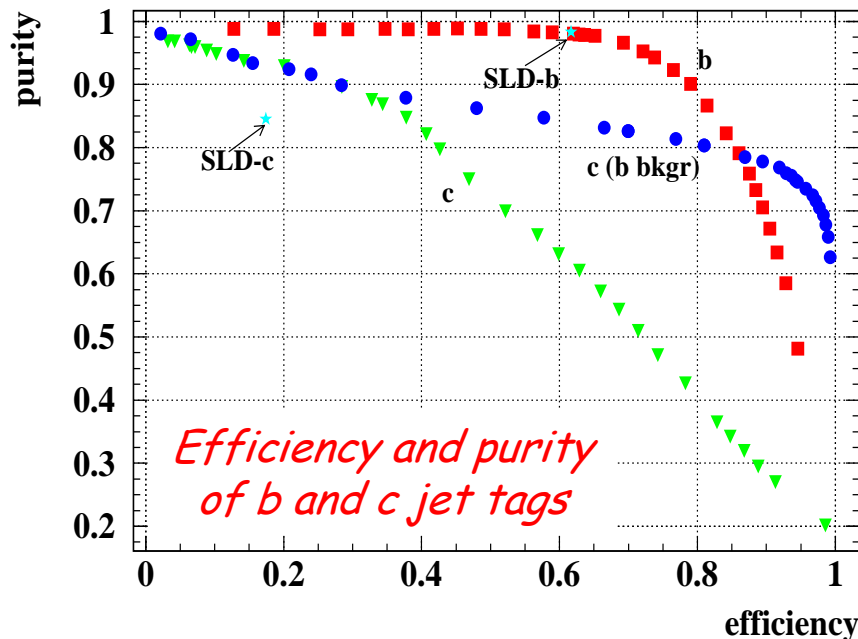

# Physics Studies: From MIPS to Physics

*Charge deposition,  
clustering, sparsification,  
track fitting*

*Vertexing, track  
attachment,  
topological dependence*

*Impact on physics  
quantities, individual  
physics channels*

The sensors studied are *new devices*; we need to model how they work.

o We will need to develop understanding of:

- Charge generation, propagation, and collection in new sensor types
- Cluster finding, sparsification, fitting to tracks
- Background effects and environment

*→ Provides feedback to sensor and electronics design*

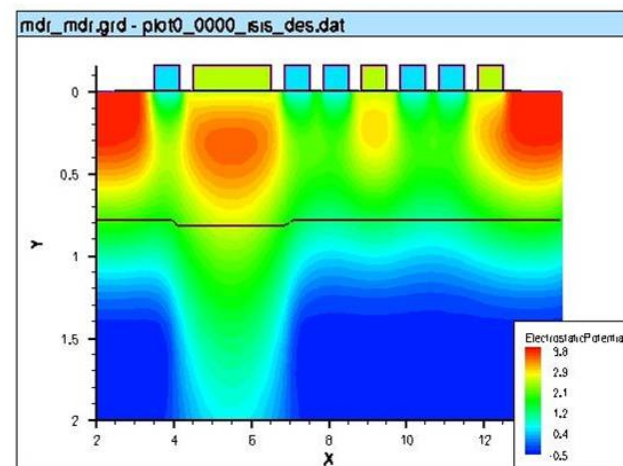
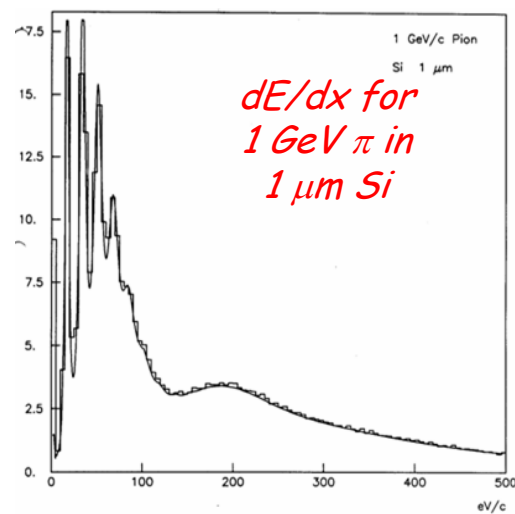

# Physics Studies: From MIPS to Physics

Charge deposition,  
clustering, sparsification,  
track fitting



Vertexing, track  
attachment,  
topological dependence



Impact on physics  
quantities, individual  
physics channels

## Study factors affecting flavour identification and quark charge

- Optimise flavour ID and extend quark charge determination to  $B^0$ .
- Examine effects of sensor failure.
- Detector alignment procedures and effects of misalignments.
- Polar angle dependence of flavour and charge identification.

→ Provides feedback to mechanical design; can shape overall detector design, e.g. additional layers, increased detector length

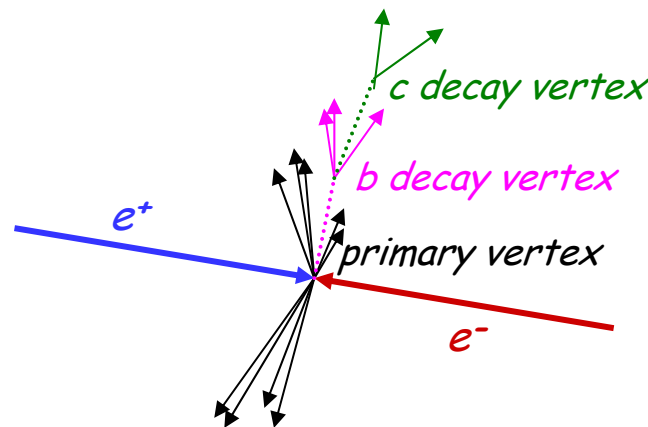
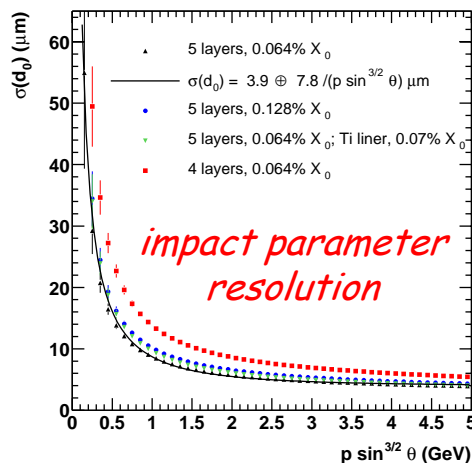

May 26, 2005

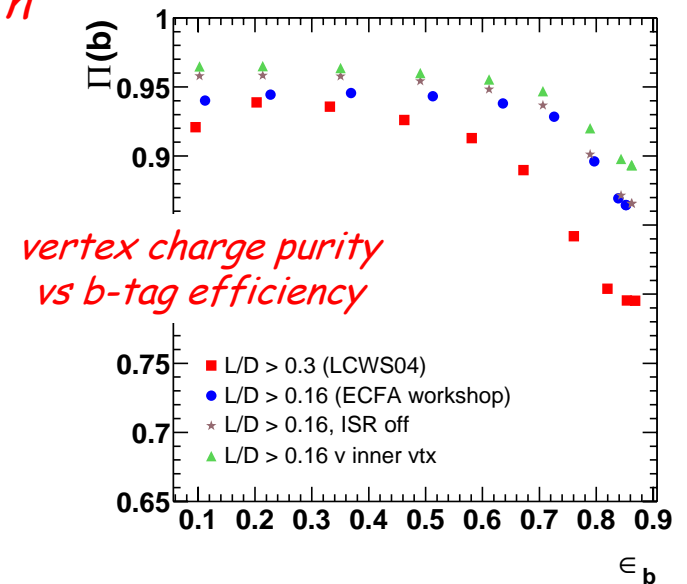

# Physics Studies: From MIPS to Physics

*Charge deposition,  
clustering, sparsification,  
track fitting*



*Vertexing, track  
attachment,  
topological dependence*



*Impact on physics  
quantities, individual  
physics channels*

- o With complete simulation, study physics processes for which vertex detector is crucial, for example:
    - Higgs branching fractions, requires flavour ID.
    - Higgs self-coupling, requires flavour and charge ID.
    - Charm and bottom asymmetries, requires flavour and charge ID.
- *Plan to be prepared to react to discoveries at the LHC, and to show detector impact on physics.*

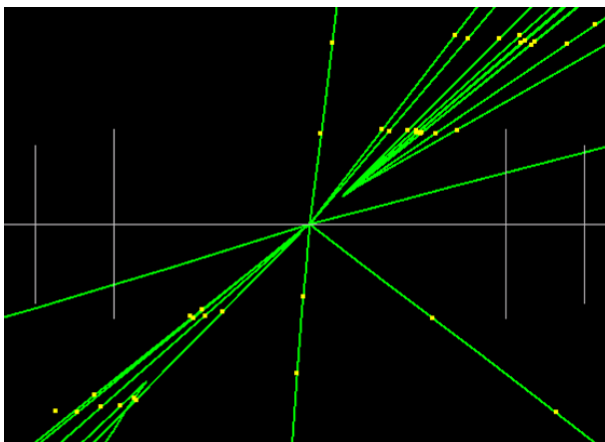

Steve Worm - LCFI

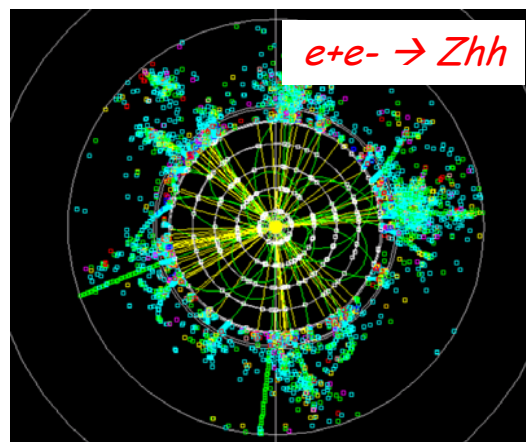

May 26, 2005

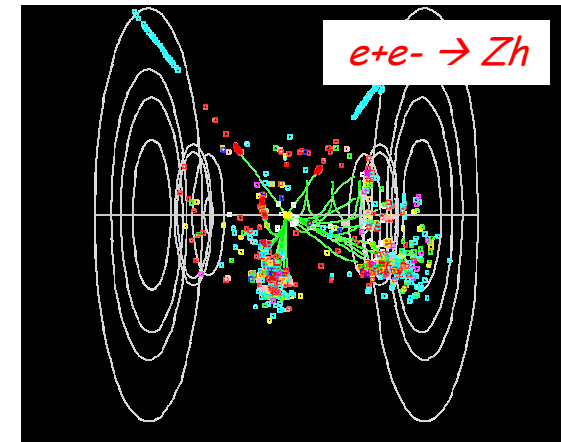

# Tracking and Timing Features at the Linear Collider

*What sort of tracking and vertexing is needed for the Linear Collider?*

- o Vertex detectors for the Linear Collider will be *precision devices*
  - Need very thin, low mass detectors
  - No need for extreme radiation tolerance
  - Need high precision vertexing → eg  $\sim 20 \mu\text{m}$  pixels
  - Can not simply recycle technologies used in LHC or elsewhere
- o High pixelization and readout implications
  - $10^9$  pixels: must break long bunch trains into small bites ( $2820/20 = 141$ )
  - Read out detector many (ie 20) times during a train → susceptible to pickup
  - ...or store info for each bite and read out during long inter-train spaces

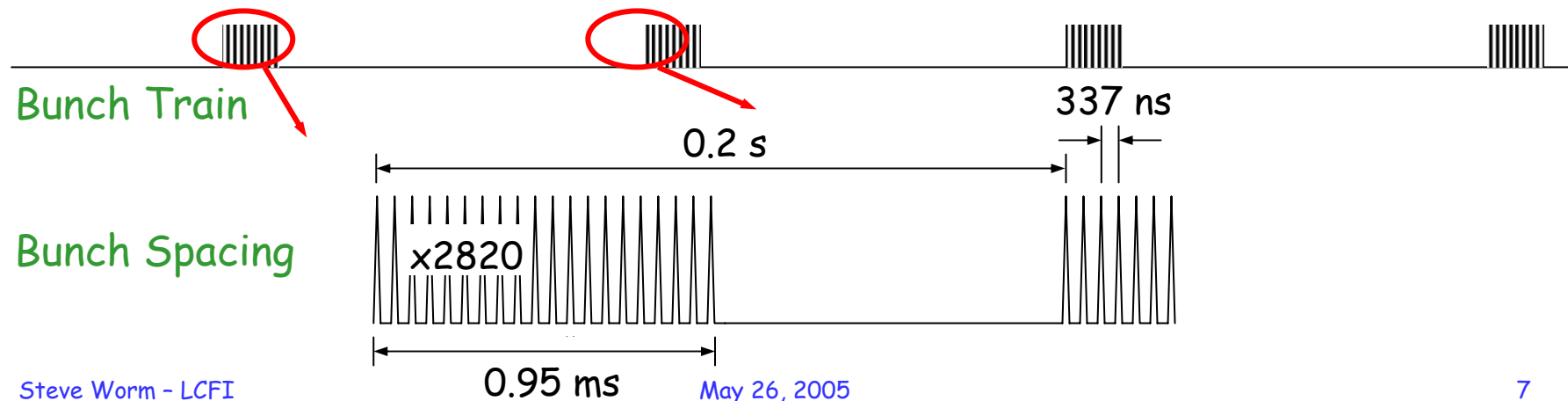

# Sensors for the ILC vertex detector

*ILC long bunch trains,  
~10<sup>9</sup> pixels, relatively  
low occupancy*



Read out *during* the bunch train:

## o Fast CCDs

- Development well underway
- Need to be fast (50 MHz)
- Proven track record at SLD
- Need to increase speed, size
- Miniaturise drive electronics

Read out in the *gaps*:

## o Storage sensors

- Store the hit information, readout between bunch trains (exploit beam structure)
- Readout speed requirements reduced (~1MHz)
- Can design to minimise sensitivity to electromagnetic interference
- Two sensor types under study: ISIS and FAPS



## Sensors: Column-Parallel CCDs

- o **Fast Column-Parallel CCD's (CPCCD)**
  - CCD technology proven at SLD, but LC sensors must be faster, more rad-hard
  - Readout in parallel addresses speed concerns
  - CPCCD's feature small pixels, can be thinned, large area, and are *fast*
  - CPC1: Two phase, 400 (V) × 750 (H) pixels of size  $20 \times 20 \mu\text{m}^2$

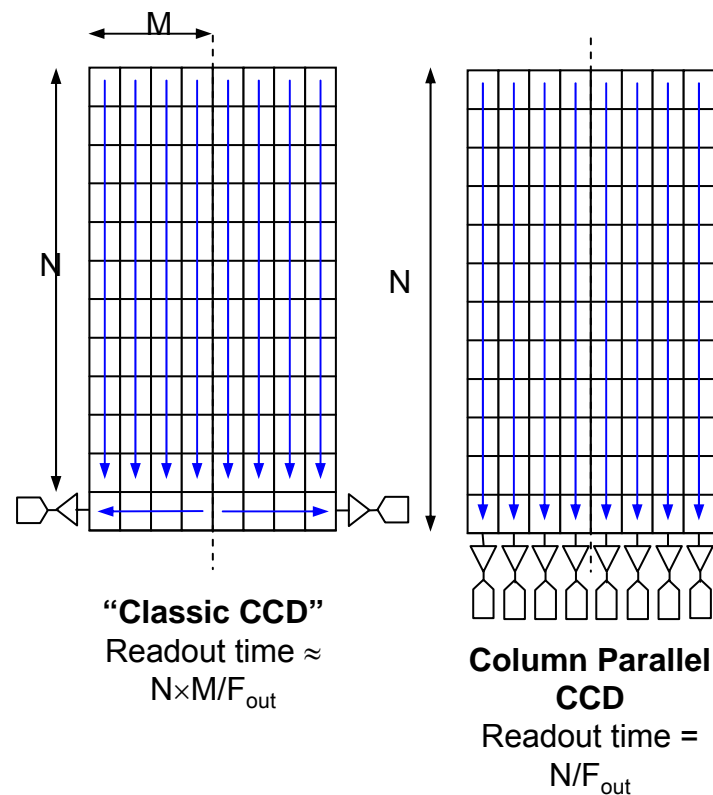

*Bump-Bonded CPCCD + Readout*

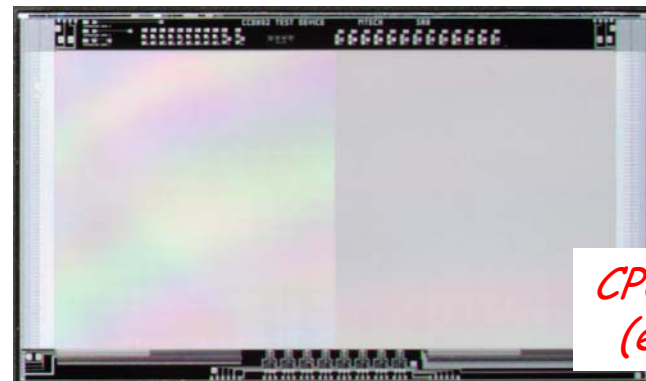
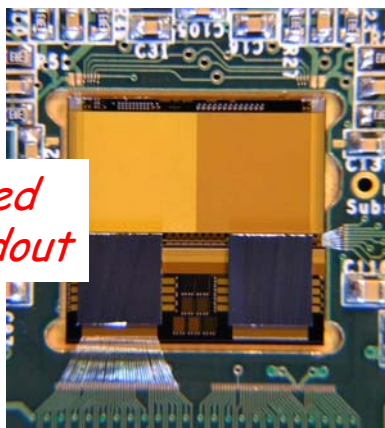

*CPCCD1 (e2v)*

# Column-Parallel CCDs: Recent Results

- o First-generation tests (CPC1):
  - Noise  $\sim 100 e^-$  ( $60 e^-$  after filter).
  - Minimum clock potential  $\sim 1.9$  V.
  - Max clock frequency above 25 MHz (design 1 MHz).
  - Limitation caused by clock skew

- o Next generation in production (CPC2):
  - Busline free design (two-level metal)
  - Tests stitching, and choice of epi layers for varying depletion depth
  - Range of device sizes for test of clock propagation (up to 50 MHz)
  - Large chips are nearly the right size

*Extremely successful!*

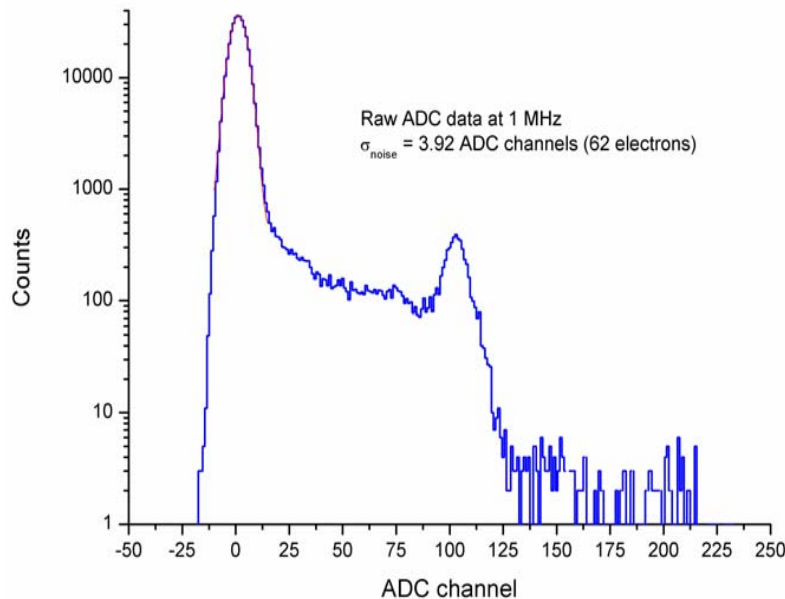

Steve Worm - LCFI

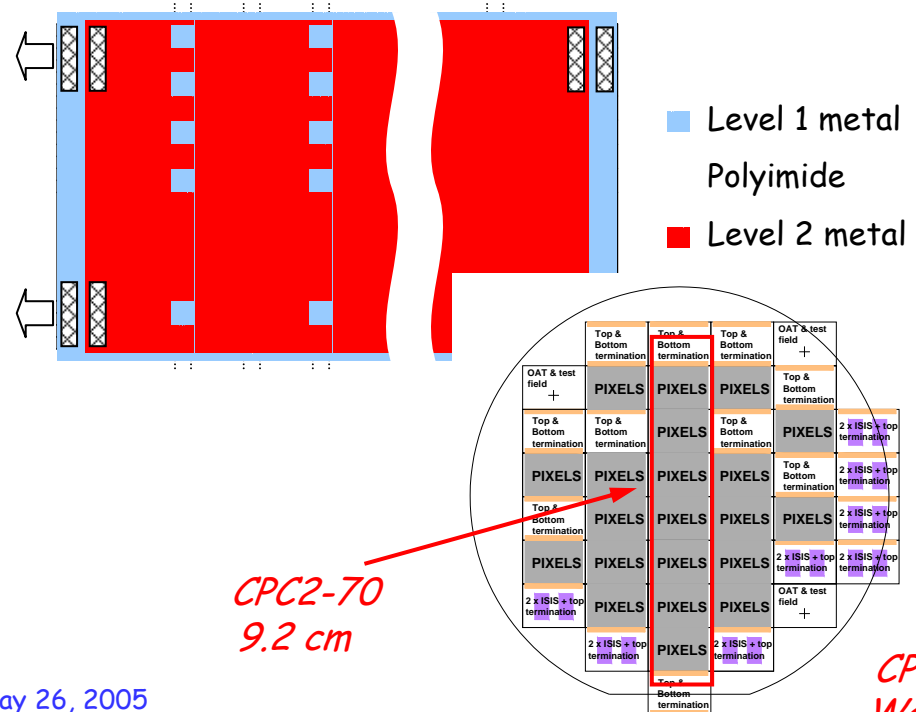

May 26, 2005

## Storage Sensors: ISIS

- o Can store charge for many crossings
  - ISIS: In-situ storage image sensor
  - Signal stored safely until bunch train passed
  - Test device being built by e2v

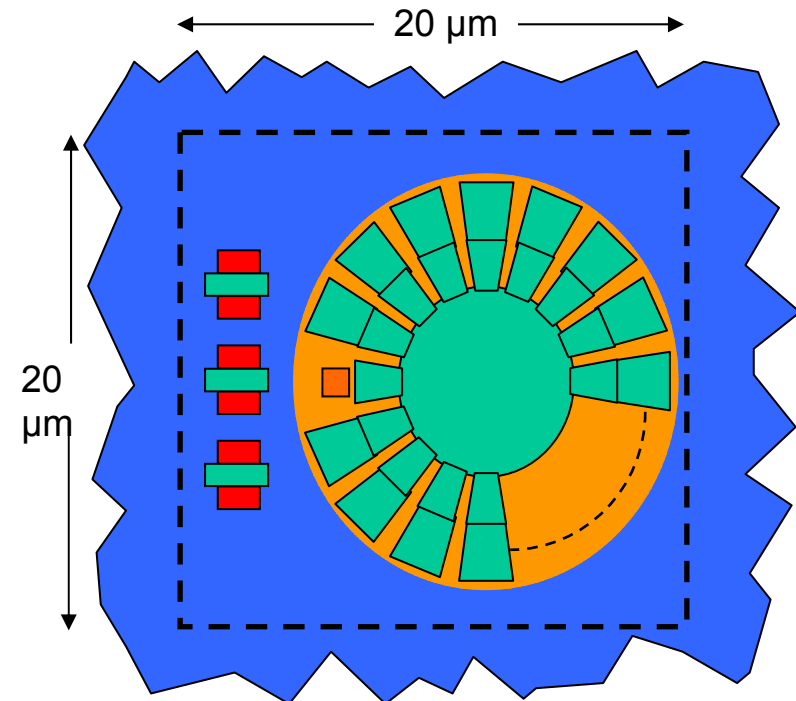
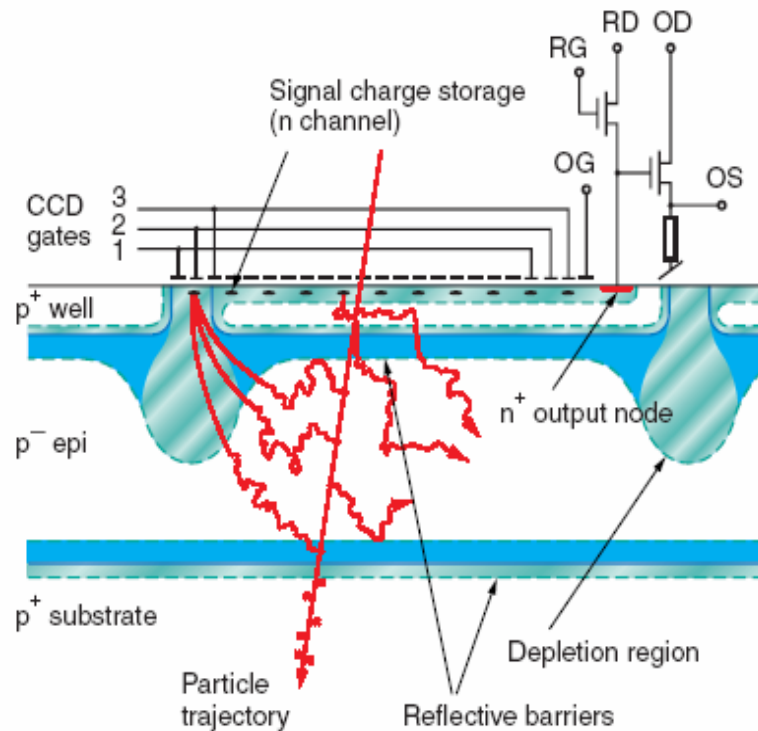

- o "Revolver" variant of ISIS
  - Reduces number charge transfers
  - Increases radiation hardness and flexibility

→ *No shortage of good ideas*

# Storage Sensors: ISIS

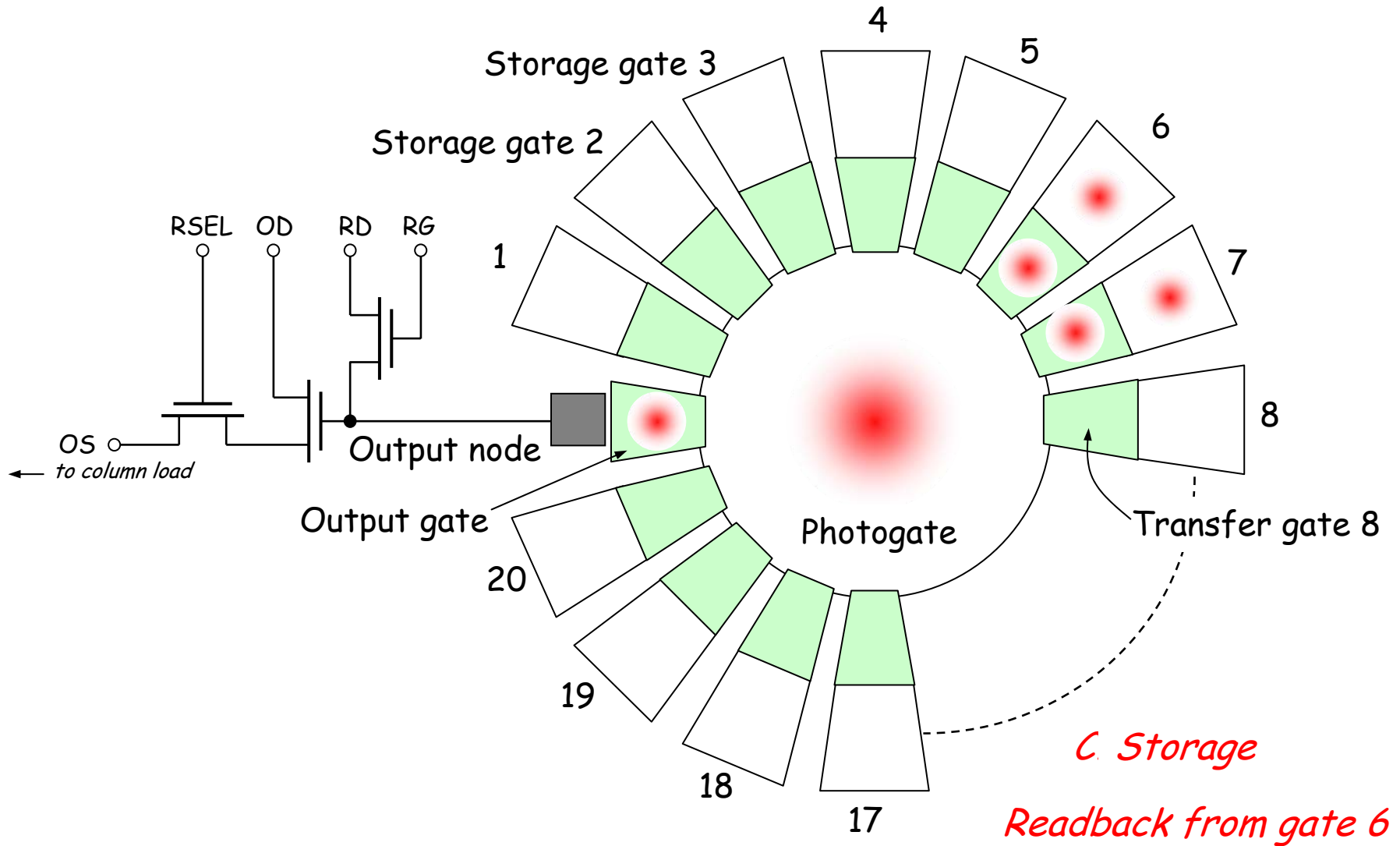

# Storage Sensors: FAPS

## o FAPS architecture

- Flexible active pixel sensors
- Adds pixel *storage* to MAPS
- Present design "proof of principle" test structure
- Pixels  $20 \times 20 \mu\text{m}^2$ , 3 metal layers, 10 storage cells

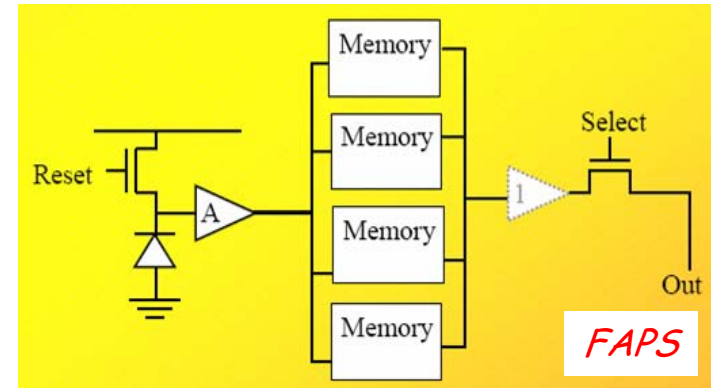
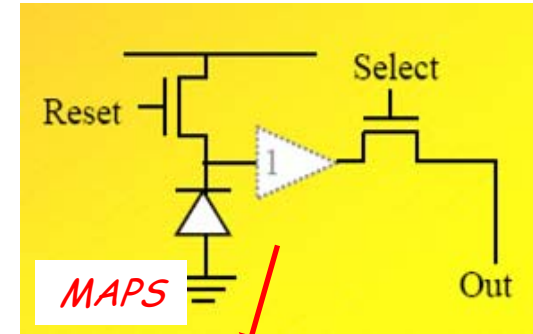
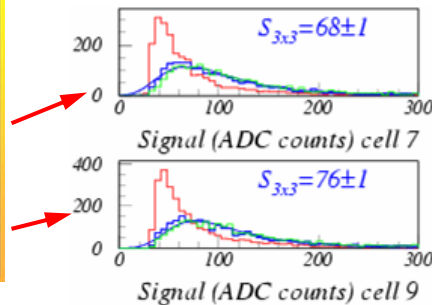
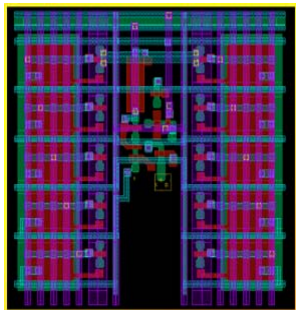
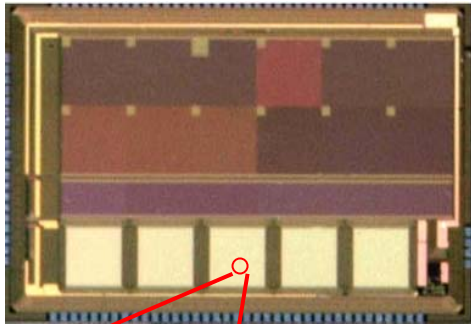

## o Results with initial design:

- $^{106}\text{Ru}$   $\beta$  source tests: Signal to noise ratio between 14 and 17.
- MAPS shown to tolerate high radiation doses.

# Storage Sensors: FAPS plans

- o Next step: Parametric test sensor
  - 64x64 identical pixels (at least)
  - Variants of write and read amplifiers and in storage cells
- o Will evaluate pixels in terms of
  - Noise
  - Signal
  - Radiation hardness
  - Readout speed
- o Optimisation is between
  - size of the pixel
  - readout speed
  - maximum amount of time available for readout
  - charge leakage

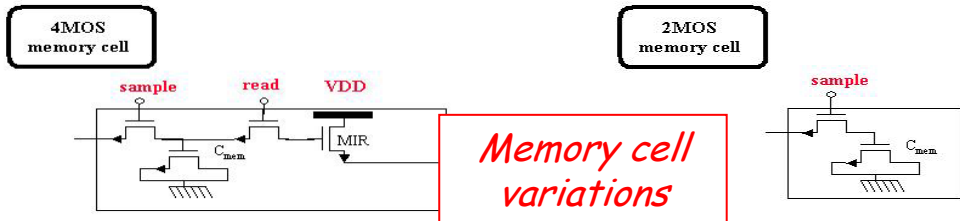

Steve Worm - LCFI

May 26, 2005

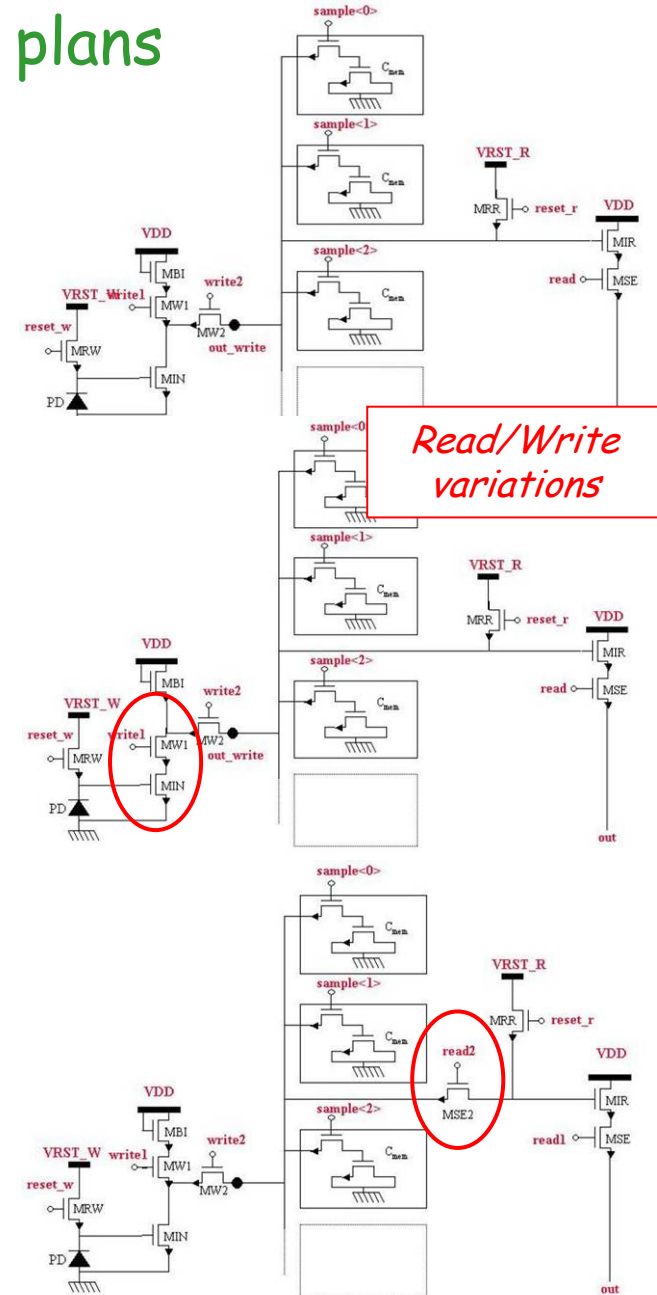

## Readout Electronics: CPR2 Readout Chip

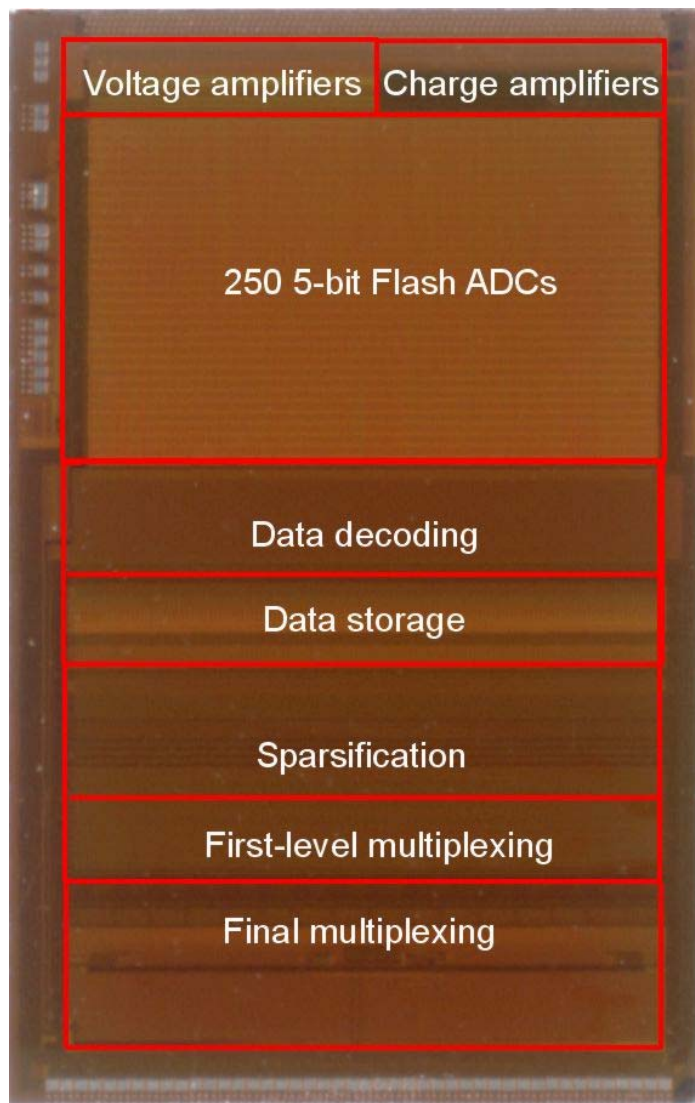

- o Designed to match the Column Parallel CCD (CPC1 or CPC2)
  - 20 $\mu$ m pitch, maximum rate of 50MHz
  - 5-bit ADC, on-chip cluster finding
  - Charge and voltage inputs
- o New features for the CPR2 include
  - Cluster Finding logic, Sparse read-out
  - Better uniformity and linearity
  - Reduced sensitivity to clock timing
  - Variety of test modes possible
  - 9.5 mm x 6 mm die size, IBM 0.25 $\mu$ m
  - Recently delivered, testing beginning

*→ Major piece needed for a full module*

# Vertex Detector Mechanical Studies

- o Thin Ladder (module) construction Goals are ambitious;
  - 0.1 %  $X/X_0$  → Thinned silicon sensor, ultra-light support
  - Wire or Bump bondable, robust under thermal cycling
- o Materials and mechanical support technology under study
  - Carbon fibre, carbon foam, Silicon carbide foam, diamond, beryllium, etc.
  - Reticulated vitreous carbon (RVC) foam; 3% relative density, 3.1 mm = 0.05%  $X_0$
  - Several interesting new materials available

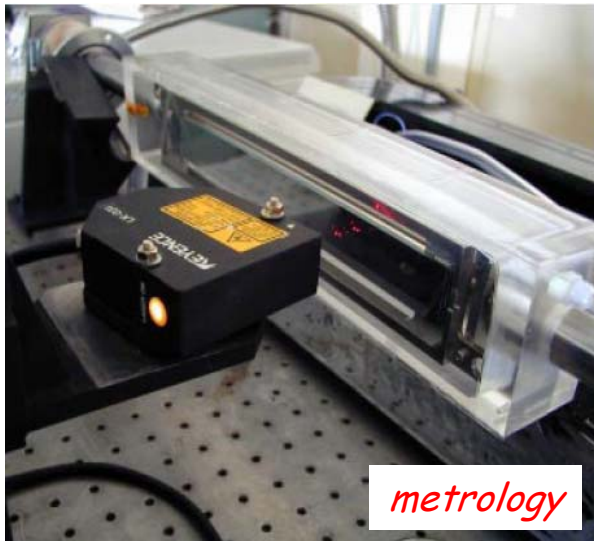

Steve Worm - LCFI



May 26, 2005



16



# Mechanical Studies: Support Structures

## Thin Ladder Mechanical Considerations

- Stresses introduced in processing imply "unsupported" Si > 50 $\mu$ m.
- "Stretching" maintained longitudinal stability, but insufficient lateral support.
- Re-visit using thin corrugated carbon fibre to provide lateral support.

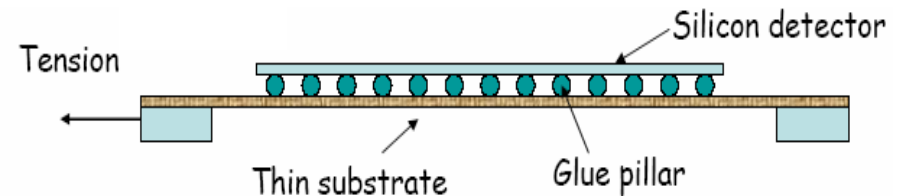

## Measurement and Stress Analysis

- Supporting CCD on thin substrate studied at low temperatures.
- Simulation (FEA) provides good guide.
- Under study: sandwiched structure with foams.

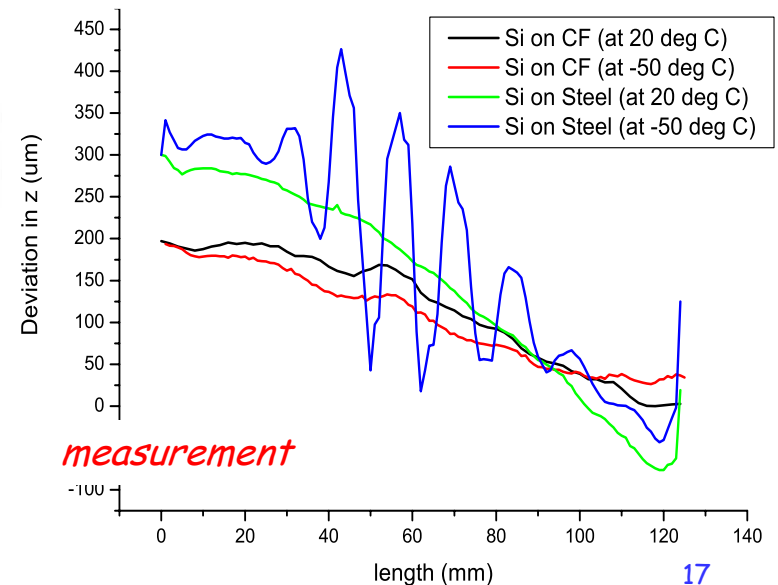
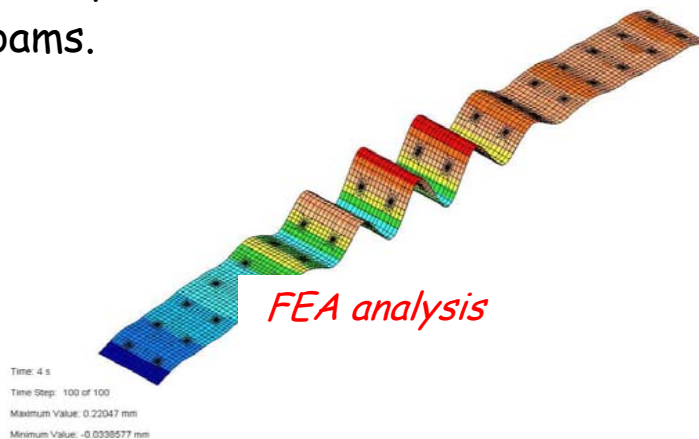

# Vertex Detector Global and Thermal Studies

- o Mounting schemes, layout, services, cooling etc
  - Must all be shown to be compatible with candidate technology
  - Large dependence on decisions in other work (e.g. sensors, electronics)
  - Thermal test stand under construction
- o Many mechanical challenges ahead
  - How to hold the ladders
  - Full detector layout
  - Thermal studies
  - How to cool the ladders
  - Stress analysis for candidate ladder support

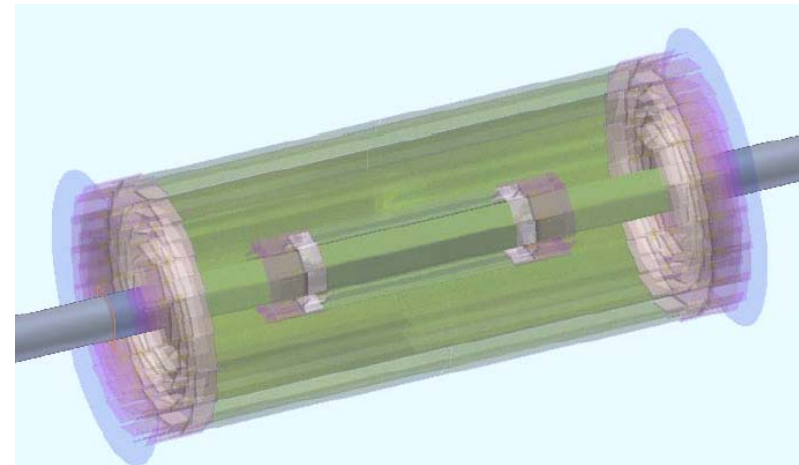

→ *Many interesting mechanical challenges*

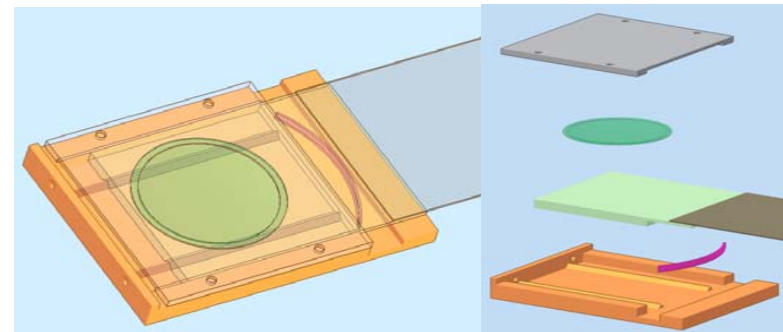

# Testbeams and Electromagnetic Interference

*LCFI is actively developing test-beam capability with an aim to:*

- o Understand the impact of the environment at the ILC on our sensors.
  - Beam induced RF had a serious impact on the SLD vertex detector.
  - The MDI panel of the world-wide study has identified EMI as one of the key issues to be addressed.
  - Collaborating with SLAC, US, and Japanese groups
  
- o Test full-sized prototype detector modules in a test-beam, including the study of:
  - Single hit efficiency
  - Influence of high magnetic fields
  - Resolution
  - Readout speed
  - Sparsification algorithms
  - Noise susceptibility

# Linear Collider Flavour Identification: Proposal and Goals

*The LCFI collaboration has enjoyed 3 years of success in ILC vertex detector R&D*

- o The new programme of work moves us from Research into prototype detector *Development*
  - Overall goal is to have a fully-functional and test-beam proven detector module, including sensors, readout, and mechanical support, ready in 2010.
  - The challenge is to take bench-top devices and develop them into fully functioning modules
  - Successful development will put us in a good position to help build the ILC vertex detector
- o New proposal includes
  - 5 institutions
  - 58 people, plus several students
  - 7 new RA posts

Linear Collider Flavour Identification Case for Support — F306

**Linear Collider Flavour Identification: Case for Support**  
27 April 2005

P Allport<sup>1</sup>, D Bailey<sup>1</sup>, C Buttar<sup>2</sup>, D Cussans<sup>1</sup>, C J S Damerell<sup>1</sup>, J Fopma<sup>4</sup>,  
B Foster<sup>2</sup>, S Galagedera<sup>3</sup>, A R Gillman<sup>1</sup>, J Goldstein<sup>1</sup>, T J Greenshaw<sup>1</sup>, R Halsall<sup>1</sup>, B Hawes<sup>2</sup>,  
K Hayrapetyan<sup>1</sup>, H Heath<sup>1</sup>, S Hillert<sup>1</sup>, D Jackson<sup>3,5</sup>, E L Johnson<sup>1</sup>, A J Lintern<sup>1</sup>, P Murray<sup>1</sup>,  
A Nichols<sup>2</sup>, A Nomerotski<sup>1</sup>, V O'Shea<sup>1</sup>, K D Stefanov<sup>1</sup>, S L Thomas<sup>1</sup>, R Turchetta<sup>1</sup>,  
M Tyndel<sup>1</sup>, J Velthuis<sup>1</sup>, G Villani<sup>1</sup>, S Worm<sup>1</sup>, S Yang<sup>1</sup>

1. Bristol University
2. Glasgow University
3. Liverpool University
4. Oxford University
5. Rutherford Appleton Laboratory

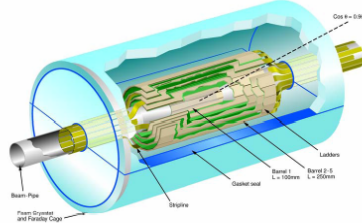

**Abstract**

The Linear Collider Flavour Identification (LCFI) Collaboration is developing the sensors, electronic systems and mechanical support structures necessary for the construction of a high performance vertex detector at the e<sup>+</sup>e<sup>-</sup> International Linear Collider (ILC). The Collaboration's goal is to produce and test, in five years time, full-scale sensors with the accompanying electronics, support and cooling systems necessary for application at the ILC. These must allow polar angle coverage in the range  $|\cos\theta| < 0.96$ , readout or signal storage within 50  $\mu$ s, and have a material budget of at most 0.1% X<sub>0</sub> for normally incident particles, providing an impact parameter resolution of  $\leq 5$   $\mu$ m for tracks with momentum as low as 1 GeV/c. The sensor development will build on the Collaboration's expertise with column-parallel CCDs and will include devices with in-pixel data storage. Readout circuits for these sensors will be designed with on-chip clustering and data sparsification algorithms. Studies of materials allowing the construction of extremely low mass supports for these sensors will be undertaken in conjunction with studies of the mechanical design of the vertex detector. The Collaboration's flavour tagging and heavy flavour charge identification investigations will be extended both to optimise the vertex detector design and to maximise the physics potential of the ILC.

# Linear Collider Flavour Identification: Summary

- Progress made in understanding physics accessible at the ILC via:
  - Flavour identification.
  - Determination of b, c charge.
- Column Parallel CCD development progressing:
  - LCFI will soon have sensors of scale close to that required for the ILC.
  - Beginning to address remaining challenge of low mass drive circuitry.
- Storage sensor studies initiated: looks extremely promising
- Mechanical studies have demonstrated:
  - Unsupported Si will not result in lowest mass sensors.
  - Emphasis shifted to new materials.
- Milestones met or surpassed in last three years.

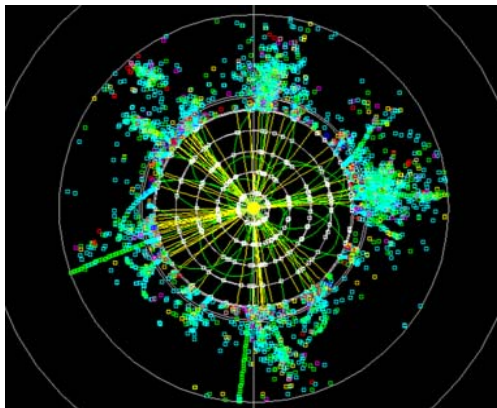

Steve Worm - LCFI

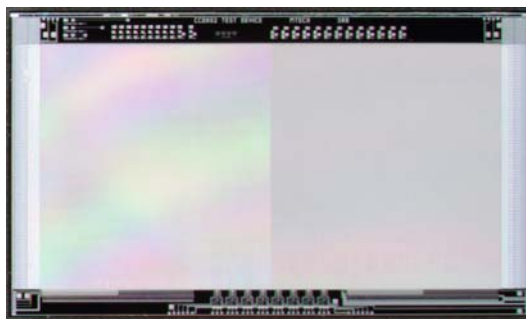

May 26, 2005

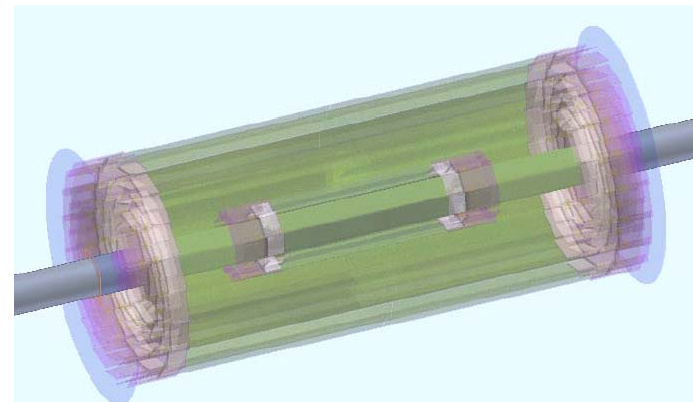



*backup slides...*

# Bump-Bonding, Radiation Damage

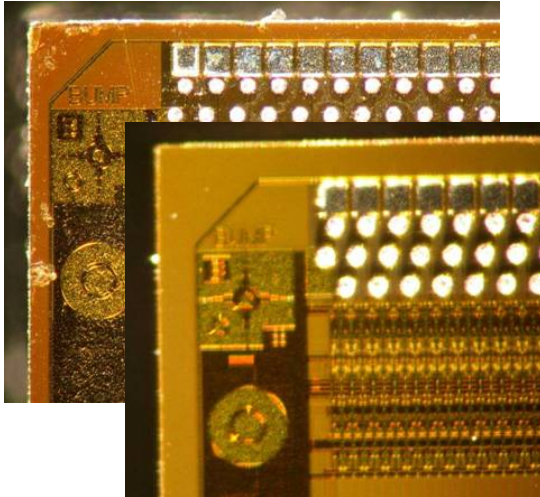

## o Bump-bonding

- Standard in semiconductor packaging... but not for small quantities, large devices, thinned devices...
- Necessary for dense, low-inductance connections
- Primarily overseen by RAL, but Glasgow and Liverpool groups have experience

## o Radiation Damage studies

- For any new vendor we will need to characterise the production process for resistance to radiation
- Test bulk and surface damage for each sensor type
- Look for charge transfer inefficiency (CTI) in CPCCD, ISIS
- Much individual testing needed (time consuming)
- Comparison to simulation, feedback to sensor design

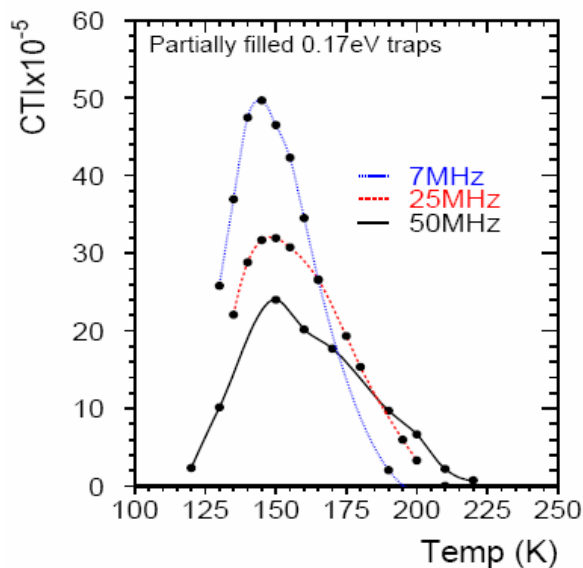



# Driver Design Issues for CPCCD

## o High Current

- Problem supplying ~10A to driver IC (thick wires)
- Solution may be capacitive storage (charged at low rate between bunch trains, discharged at high rate when CCD is clocked during bunch train)

## o Waveform shape and timing

- The driver IC will provide a high degree of control over the waveform
- Shape and timing of CCD clock could be fine tuned to match readout IC timing
- Adjustable clock drive voltage (aim to minimise power, without degrading charge transfer efficiency)

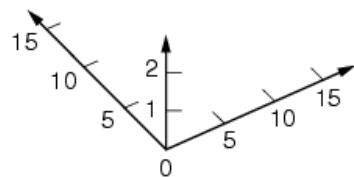
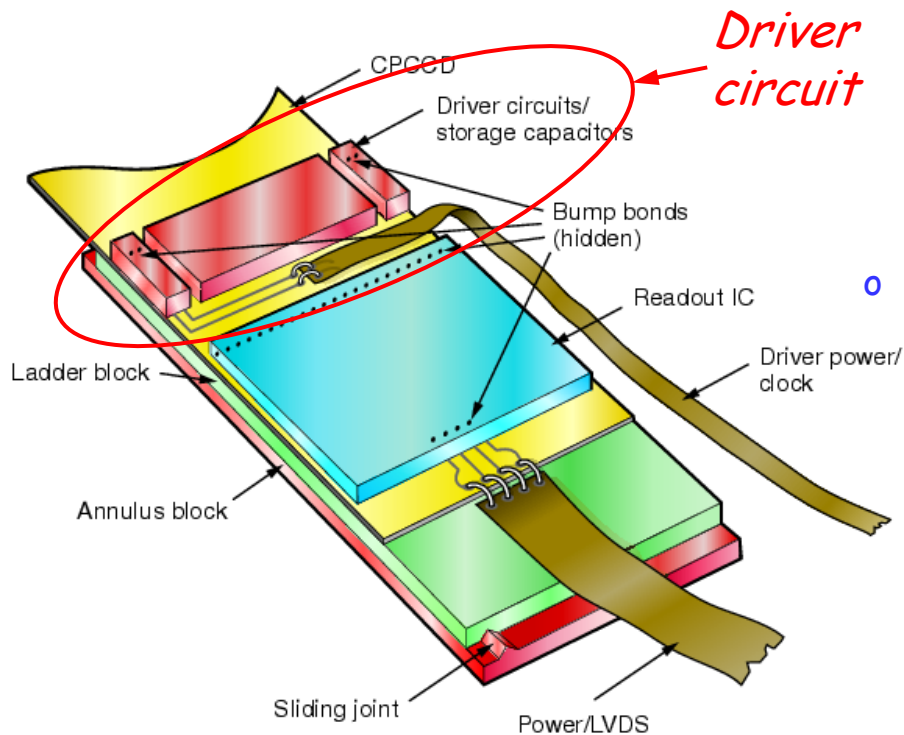

Steve Worm - LCF1

may 20, 2005

25

# Storage Sensors - ISIS

## o ISIS Sensor details:

- CCD-like charge storage cells in CMOS technology
- Processed on sensitive epi layer
- p+ shielding implant forms reflective barrier (deep implant)
- Dual oxide thickness possible (Jazz Semiconductor)
- Overlapping poly gates not likely in CMOS, may not be needed

## o Basic structure shown below:

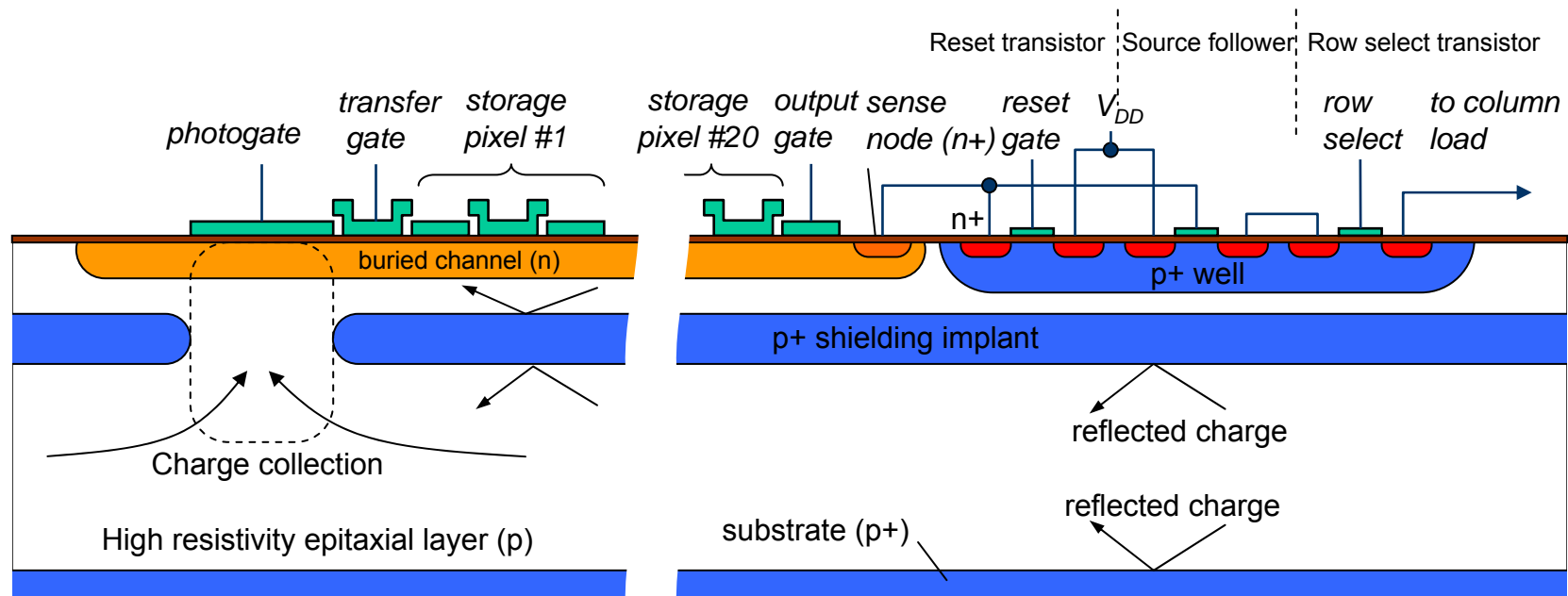

# Storage Sensors - ISIS

- o Standard CMOS process doesn't allow overlapping polysilicon or two thicknesses of oxide.
  - Modify dopant profiles to produce deeper buried channel: single oxide
  - Charge transfer is efficient, despite non-overlapping gates

→ *Sensor properties and design under study, looks promising*

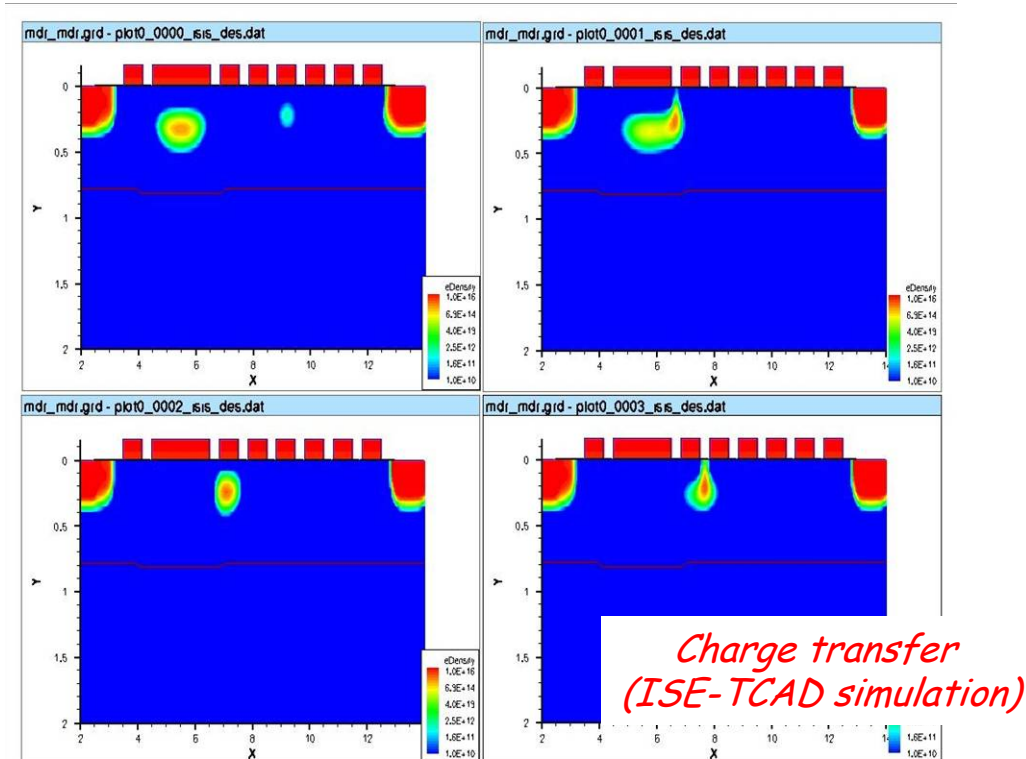

---

## PHYSICS JOBS

### JOB DETAILS

#### Three New Opportunities

The University of Liverpool  
L69 3BX  
United Kingdom

**Closing date:** 31 May 2005

**Job reference code:** B/479, B/477, B/478

**Salary:** not specified

**Qualification:** Doctorate (PhD/DPhil/DEng/Dr.-Ing.)

---

The University of Liverpool  
HIGH ENERGY PHYSICS GROUP  
DEPARTMENT OF PHYSICS

Three exciting new opportunities are available in key areas of the research programme of the High Energy Physics (HEP) group (<http://hep.ph.liv.ac.uk/>)

Senior Experimental Officer: Pixel Detectors  
Salary from £22,507 pa

The appointment is for a physicist to take a leading role in the semiconductor pixel detector programme which is based on Monolithic Active Pixel Sensors (MAPS) and on CCD technologies for track and vertex detectors at future experiments. The MAPS work is funded by PPARC and by the RC-UK Basic Technology initiative in the Multidimensional Integrated Intelligent Imaging (M-I3) consortium. The CCD work is a PPARC initiative focused on the read-out requirements of the International Linear Collider (ILC) as part of the Linear Collider Flavour Identification Collaboration (LCFI). The facilities of the Liverpool Semiconductor Detector Centre (<http://hep.ph.liv.ac.uk/lscd/>) underpin all semiconductor detector R&D in Liverpool.

Candidates should hold a PhD in experimental particle physics, or allied research involving position-sensitive detectors. Familiarity with microelectronics characterisation, with sensors for radiation detection, and/or with the calibration, operation and data analysis of large array detectors in High Energy Physics experiments, would be a strong advantage. The post, based in the Department of Physics, is available immediately.

Quote Ref: B/479 Closing Date: 31 May 2005