

P310 Report Writing

Prof. Ritchie Patterson
Spring, 2006

Writing P310 Reports

Measurement of the mean lifetime of cosmic ray muons

Igor Kozachenko

N-15

Cornell University, Ithaca, NY 14853

December 4, 2000

Abstract

The mean lifetime of cosmic ray muons stopped in a scintillator was determined by the delayed coincidence technique. The time lapses ($<6 \mu\text{s}$) between the stopping of a muon in the plastic scintillator and its subsequent decay were sorted into six discrete time bins by electronic circuitry. The obtained integral time distribution of the delayed coincidences was used to calculate the mean lifetime. Correction was made for the nuclear capture of negatively charged muons μ^- by atoms in the scintillator. Using the relative abundance of positively and negatively charged muons at sea level $\mu^+/\mu^- = 1.06 \pm 0.03$, measured by Morewitz and Shamos [3], the mean lifetime in vacuum was found to be $2.236 \pm 0.046 \mu\text{s}$. This is in good agreement with the accepted value of $2.19703 \pm 0.00004 \mu\text{s}$.

I. Introduction

The primary cosmic rays from outer space entering the upper atmosphere consist of protons, α -particles, a few heavier nuclei and gamma rays. Interaction with the air nuclei in the upper atmosphere produces a secondary flux of protons, neutrons and two forms of π -mesons: neutral and charged. The short lifetime of pions prohibits them from reaching the Earth's surface. Neutral π -mesons decay ($\tau_{\pi^0} = 0.8 \times 10^{-10} \mu\text{s}$) into photons, while the charged π -mesons decay ($\tau_{\pi^\pm} = 0.8 \times 10^{-2} \mu\text{s}$) to muons plus neutrinos. High altitude observations show that most of the muons that arrive at sea level are created above 15 km [1]. At sea level, muons are the primary constituent of cosmic rays, accounting for 80% of all cosmic radiation. Muons (+ or -) carry the same charge as an electron, but their mass $\sim 100 \text{ MeV}$ is much greater than electron mass $\sim 0.5 \text{ MeV}$. Muons are characterized by a relatively short lifetime of about $2.197 \mu\text{s}$ [2]. However, the fact that the majority of these muons are observed at sea level is direct evidence that cosmic ray muons are highly relativistic, i.e. they travel with a speed comparable to the speed of light. The relativistic time dilation in the Earth's reference frame is large enough that muons can travel 15 km without decaying. Equally important, their large kinetic energy allows the muons to pass through substantial amounts of matter without stopping. Muons belong to the lepton family, so that they are subject to weak interaction and decay into electrons and neutrinos

$$\mu^+ \rightarrow e^+ + \nu_e + \bar{\nu}_\mu \quad (1)$$

$$\mu^- \rightarrow e^- + \bar{\nu}_e + \nu_\mu$$

This experiment uses plastic scintillators to detect cosmic ray muons. When struck by ionizing radiation, scintillators produce photons in the optical range, which can be detected by photomultiplier tubes. Most cosmic ray muons have enough kinetic energy to pass through the scintillators without stopping. These scintillators are capable of stopping an incident muon with kinetic energy less than 100 MeV . Stopped muons undergo the decays displayed in (1). Produced

• Look at one student's P510 report in detail, and take examples from several others.

Header material

Measurement of the mean lifetime of cosmic ray muons

I.M. Anonymous

N-15

Cornell University, Ithaca, NY 14853

December 4, 19xx

- Title
- Your name
- Experiment number
- Date

Abstract

Abstract

(1)

The mean lifetime of cosmic ray muons stopped in a scintillator was determined by the delayed coincidence technique. The time lapses ($<6 \mu\text{s}$) between the stopping of a muon in the plastic scintillator and its subsequent decay were sorted into six discrete time bins by electronic circuitry. The obtained integral time distribution of the delayed coincidences was used to calculate the mean lifetime. Correction was made for the nuclear capture of negatively charged muons μ^- by atoms in the scintillator. Using the relative abundance of positively and negatively charged muons at sea level $\mu^+/\mu^- = 1.06 \pm 0.03$, measured by Morewitz and Shamos [3], the mean lifetime in vacuum was found to be $2.236 \pm 0.046 \mu\text{s}$. This is in good agreement with the accepted value of $2.19703 \pm 0.00004 \mu\text{s}$.

(2)

(3)

- Should be a few sentences long.
- 1. Say what quantity you measured.
- 2. Describe the gist of the procedure.
- 3. State your result with error.

Better to avoid
refs in abstract

Body of text

- I. Introduction
- II. Theoretical Background
- III. Experimental Set-up
- IV. Calibration and adjustment of the experimental setup
 - Finding the optimum PMT voltage**
 - Calibration of the electronic bins**
- V. Results and Discussion
 - Experimental data**
 - Background counts**
 - Determination of the effective lifetime**
 - Correction for the capture of negative muons**
- VI. Conclusion
- VII. References

Your section headings may be slightly different to match your needs.

Variations on a theme - Outlines

- I. Introduction
- II. Theoretical Background
- III. Experimental Set-up
- IV. Procedure
- V. Data
- VI. Analysis
- VII. Conclusion

- I. Introduction
- II. Basic Theory
- III. Set-up
- IV. Experiment and Data
- V. Additional Comments on Error; Conclusion
- VII. Acknowledgements

- I. Introduction
- II. Theoretical Background
- III. Experimental Set-up
- IV. Calibration
- V. Results and Discussion
- VI. Conclusion
- VII. References

- I. Introduction
- II. Apparatus
- III. Theory
- IV. Results
- V. Conclusion
- VI. References

The Introduction

- Typically 1/2 to 1 page long
- Explains why the measurement is interesting
 - test a theory?
 - Beautiful experimental technique?
 - Historically pivotal?
 - other???
- Gives an overview of the procedure

Intro from our sample report

I. Introduction

Where do muons
come from?

The primary cosmic rays from outer space entering the upper atmosphere consist of protons, α -particles, a few heavier nuclei and gamma rays. Interaction with the air nuclei in the upper atmosphere produces a secondary flux of protons, neutrons and two forms of π -mesons: neutral and charged. The short lifetime of pions prohibits them from reaching the Earth's surface. Neutral π -mesons decay ($\tau_{\pi^0} = 0.8 \times 10^{-10} \mu\text{s}$) into photons, while the charged π -mesons decay ($\tau_{\pi^\pm} = 0.8 \times 10^{-2} \mu\text{s}$) to muons plus neutrinos. High altitude observations show that most of the muons that arrive at sea level are created above 15 km [1]. At sea level, muons are the primary constituent of cosmic rays, accounting for 80% of all cosmic radiation. Muons (+ or -) carry the same charge as an electron, but their mass $\sim 100 \text{ MeV}$ is much greater than electron mass $\sim 0.5 \text{ MeV}$. Muons are characterized by a relatively short lifetime of about $2.197 \mu\text{s}$ [2]. However, the fact that the majority of these muons are observed at sea level is direct evidence that cosmic ray muons are highly relativistic, i.e. they travel with a speed comparable to the

Why muons are
interesting

Why the lifetime
is interesting

MORE Intro

Key fact underlying expt, with numbers speed of light. The relativistic time dilation in the Earth's reference frame is large enough that muons can travel 15 km without decaying. Equally important, their large kinetic energy allows the muons to pass through substantial amounts of matter without stopping. Muons belong to the lepton family, so that they are subject to weak interaction and decay into electrons and neutrinos

Key fact underlying expt



Overview of method

This experiment uses plastic scintillators to detect cosmic ray muons. When struck by ionizing radiation, scintillators produce photons in the optical range, which can be detected by photomultiplier tubes. Most cosmic ray muons have enough kinetic energy to pass through the scintillators without stopping. These scintillators are capable of stopping an incident muon with kinetic energy less than 100 MeV. Stopped muons undergo the decays displayed in (1). Produced

Thinking through the underpinnings of the experiment (esp, quantitatively) is part of what makes a superb report.

And still more Intro

electrons are also detected by the scintillators. The time lapses between the ~~stopping~~ stopping of a muon and its subsequent decay are sorted in the time bins by the electronics. From the number of decays in each consecutive time interval, the mean muon lifetime can be determined.

Not all double pulses in PMT can be attributed to the decays described above. Negatively charged muons can be captured by nuclei in the scintillator material. Such muon capture is followed by emission of a neutrino and a neutron. This process is also detected by scintillators. This means that the apparent lifetime of negative muons in the scintillator is shorter than its lifetime in vacuum. Thus, for accurate calculation of the muon lifetime, it is important to correct for the greater decay rate of negatively charged muons. The ratio of μ^+ / μ^- mesons in cosmic rays at sea level has been measured by Morewitz and Shamos [3], and the capture rate can be taken from the work of Suzuki [4].

Important effect
that must be
accounted for

Theoretical Background

- Aim at peers. I.e., assume reader is another P410/P510 student and is familiar with undergrad physics
- Need to motivate expressions used in data analysis. Need **NOT** provide complete derivations. Should justify key assumptions.
- Length: ~ 1 page. May be a little shorter (1/2 page) or, for particularly complex topics, a little longer (2 pages).

Theoretical Background - Example

II. Theoretical background

The muon decay in vacuum in the rest frame of a muon is described by

$$N(t) = N(0)e^{-\lambda_d t} = N(0)e^{-t/\tau} \quad (2)$$

Make reasonable assumptions abt knowledge of reader

where $N(t)$ is a number of muons at a time t since they stopped in the scintillator, $\lambda_d = 1/\tau$ is the decay rate, and τ is the mean lifetime. If $n(t)$ is a number of decays at a time t , then the decay rate is given by the following expression

Define variables clearly

$$\frac{dn(t)}{dt} = -\left(\frac{dN(t)}{dt}\right) = \frac{N(0)}{\tau} e^{-t/\tau} \quad (3)$$

In a material, negatively charged muons are captured by nuclei, and therefore for negative muons, the decay rate λ is effectively larger

$$\lambda = \lambda_d + \lambda_c \quad (4)$$

where λ_c is the capture rate. Thus, the number of positive and negative muons at a time t will

Theory - Example (con't)

differ. Then the total number as a function of time t is given by the sum of the number of positive and negative muons

$$N(t) = N_+(0)e^{-t/\tau} + N_-(0)e^{-t/\tau - \lambda_c t}. \quad (5)$$

The decay rate at time t is given by

$$\frac{dn(t)}{dt} = N_+(0)e^{-t/\tau} \left[\frac{1}{\tau} + \frac{N_-(0)}{N_+(0)} \left(\frac{1}{\tau} + \lambda_c \right) e^{-\lambda_c t} \right]. \quad (6)$$

In the case, where $\lambda_c \ll 1/\tau$, expression (6) for the decay rate can be rewritten as

justifying this assumption

$$\frac{dn(t)}{dt} = \frac{N_+(0)}{\tau} e^{-t/\tau} \left[1 + \frac{N_-(0)}{N_+(0)} e^{-\lambda_c t} \right]. \quad (7)$$

These formulas will be employed in the subsequent analysis of the experimental data.

State assumptions,
and justify them.

Experimental Set-up

- Pictures speak 1000 words. IF they're labelled clearly.
- Verbal description to explain the figure and motivate key components. Point out any unusual aspects: eg, What is the role of the chopper? Why provide a bias voltage?...

Give enough detail to allow another student facing the same lab bench to take your data.

Experimental Setup - Example I

III. Experimental setup

Use figures

The experimental apparatus consists of a detector and a coincidence circuit block (figure 1). Muons (muon stopping events) and electrons (muon decay events) are detected by six plastic scintillating blocks containing mostly carbon and hydrogen. The fundamental mechanism of detecting ionizing radiation is the transfer of energy from the radiation to an appropriate

Explain detection mechanism

material. The primary mechanism of energy transfer for electrons and muons is inelastic collisions with atomic electrons [1]. This can lead to ionization or raising the electrons to excited states. In the scintillating material, when excited electrons decay to lower-energy states in a time on the order of 10^{-8} s, some energy is carried off by a photon (fluorescent radiation) producing a "light flash" [6].

The scintillating blocks contain also a secondary scintillating material, which "shifts" the emitted photon to a longer wavelength that ^{is better} matches the peak spectral sensitivity of the PMT, ~~photocathode~~. (The glass envelope is ^{the} problem -- it absorbs it)

Photons generated in the scintillators by stop and decay events are directed to the photomultiplier tubes by the light pipes (angled plastic). PMTs detect the "light flashes", convert them into electric pulses and amplify them.

Experimental Setup - Example II

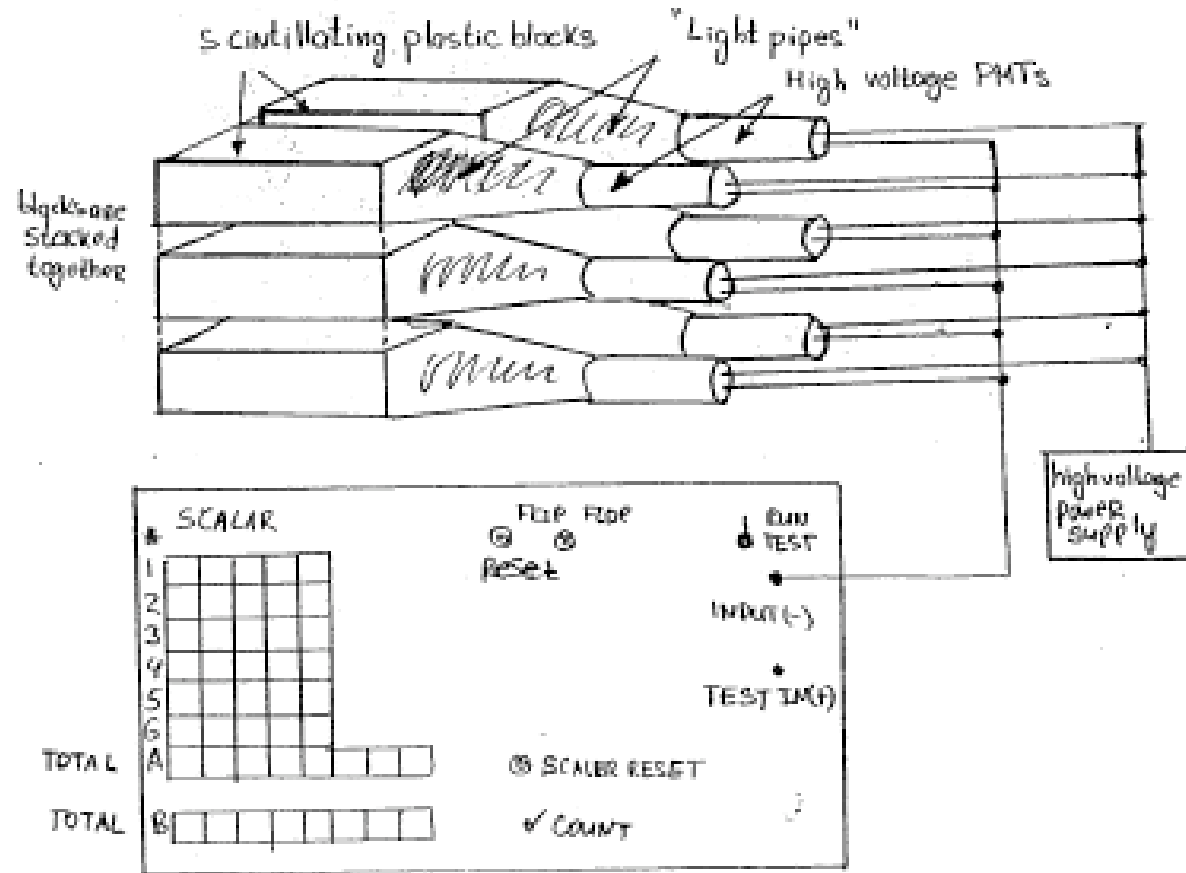

Figure 1. Schematic diagram of the apparatus.

All figures need captions

Experimental Setup - Example III

Explains operation of electronics.

A block diagram of the logic in the coincidence circuit block is shown in figure 2. The pulses from the PMTs are fed into the negative input connector. They are discriminated using a comparator. If the pulse amplitude exceeds a certain preset threshold value, the discriminator outputs a standard width and amplitude pulse. So, the discriminator rejects signals produced by the environmental noise. The pulse from the discriminator sets a flip-flop, so that no other pulse can enter the gate forming univibrators #1-6, until the flip-flop is reset by the trailing edge of the longest time bin (univibrator #6). Univibrator (d) delays the gate starting time by a fraction of a microsecond to prevent counting the stopping pulse as a decay. The six gates, generated by univibrators #1-6 are opened simultaneously, but they are closed one after another in about 1,2,3,4,5,6 μs , respectively, after opening. The output of each gate is fed into one input of the corresponding coincidence circuit. The other input to each coincidence circuit is the pulse from the discriminator (through the test/run switch and univibrator (c)). If there is a second pulse in the input, which comes in the time interval of one of the gates, the corresponding coincidence will register a count. Thus, the second pulse delayed approximately by 0.4...1 μs is counted as a decay event by scalars #1-6, the pulse delayed approximately by 1...2 μs is counted by scalars #2-6 and so on. If the delay of the second pulse exceeds the time interval of the longest gate, this pulse can already be accepted by a flip-flop and thus starts the gates again.

Experimental Setup - Example IV

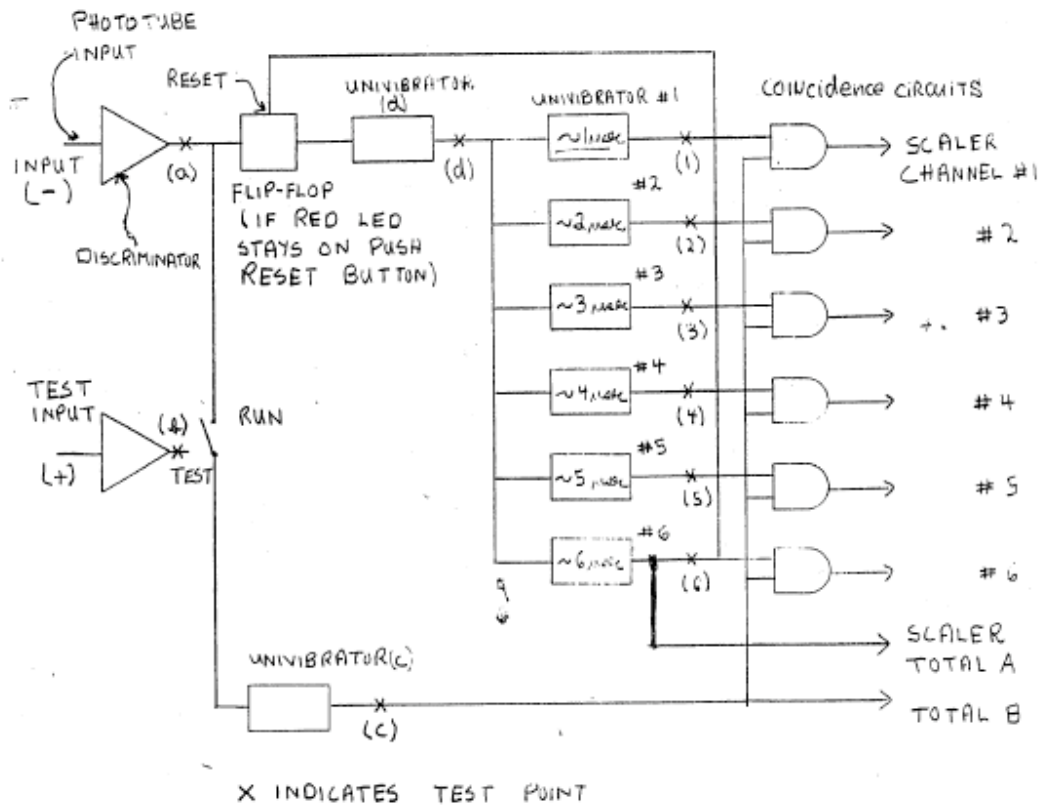

This figure is photocopied from the manual. That's fine.

Oops. Forgot caption.

Experimental Setup - Example V

Points out unexpected behavior in apparatus

Offers possible explanation.

The total number of pulses of univibrator (c) is scaled as "Total A". Scalar "Total B" counts all the pulses received from the discriminator. In the run mode these two numbers of pulses are roughly equal. We expect that the value of "Total B" should be larger or equal to the value of "Total A". This is confirmed if we test the coincidence block by feeding the two-pulse sequence from the pulse generator into the negative input in the run mode. When the pulses from the photomultiplier are fed into it, a different situation is observed - the value of "Total B" is slightly smaller than the value of "Total A". The probable reason of this situation could be the following. The signal from the PMTs is weak and noisy, and the slight discrepancy in the thresholds of "Total A" and "Total B" triggering can lead to such behavior. In any case, this fact does not affect the statistics of the detected muon decays.

Good observation !

Tries to evaluate impact on data.

This helps make this report outstanding.

Results and Discussion

- Start by summarizing data collected

Experimental data

A total of 49,024 double counts were recorded in approximately 282.75 hours (11.8 days). The number of double counts observed in the time bins #1-6 are displayed in table 2 along with the final values of scalar A and scalar B. From the total number of single pulses displayed by scalar B, the counting rate r was found to be 38278 counts/hour or 10.63×10^{-6} counts/ μ s.

Another example:

Both of these methods were then repeated for second sound. In total, two sweeps from $T \approx 1.7$ K (the lowest temperature attainable) to T_λ were made while recording with the pulse propagation method and one with the standing wave method.

Results and Discussion

- Describe analysis in enough detail so that another student with your data would arrive at the same results.
- Understand features in the data.
- Estimate errors
- Explore sources of bias

Results and Discussion - Tables

- Use Tables ...to display data

Table 2. Final counter values after running the experiment during 282.75 hours.

Scalar	Number
1	20168
2	30709
3	38562
4	43156
5	46461
6	49024
A	10897970
B	10823123

Like figures,
tables need captions

...to show data analysis

Table 3. Data used for the determination of the effective muon lifetime.

Consecutive time intervals	#1	#2	#3	#4	#5	#6
Edges (μs)	0.40-1.41	1.41-2.22	2.22-3.16	3.16-3.94	3.94-4.72	4.72-5.68
Width Δt_i (μs)	1.01 \pm 0.04	0.81 \pm 0.04	0.94 \pm 0.04	0.78 \pm 0.04	0.78 \pm 0.04	0.96 \pm 0.04
Differential number of decays Δn_i	20168 \pm 142 (0.7%)	10541 \pm 103 (1.0%)	7853 \pm 89 (1.1%)	4594 \pm 68 (1.5%)	3305 \pm 58 (1.7%)	2563 \pm 51 (2.0%)
$\Delta n_i/\Delta t_i$ ($1/\mu\text{s}$)	19968 \pm 803 (4.0%)	13014 \pm 655 (5.0%)	8354 \pm 368 (4.4%)	5890 \pm 314 (5.3%)	4237 \pm 230 (5.4%)	2670 \pm 123 (4.6%)
Center θ_i of the time interval (μs)	0.92 \pm 0.02	1.82 \pm 0.02	2.70 \pm 0.02	3.55 \pm 0.02	4.33 \pm 0.02	5.20 \pm 0.02
Weighted center θ_i^w of the time interval (μs)	0.86 \pm 0.05	1.79 \pm 0.05	2.65 \pm 0.06	3.52 \pm 0.06	4.30 \pm 0.07	5.16 \pm 0.07

Relative errors are indicated in parentheses.

Here, each line displays one step in the analysis

Results and Discussion - Tables

- ...to summarize results

Like figures,
tables need captions

Table 2. Q and c values measured by four different methods.

	<u>Q</u>	<u>Error in Q</u>	<u>c (kg-m*m/s)</u>	<u>Error in c (kg-m*m/s)</u>
Amplitude Ratio	9.77	0.29	1.19E-04	4.81E-06
Amplitude Graph	9.87	0.32	1.18E-04	4.72E-06
Phase Graph	9.73	0.31	1.19E-04	4.85E-06
Time Constant	10.17	0.36	1.14E-04	4.47E-06
Mean	9.89	0.64	1.18E-04	9.43E-06

The table makes it
easy to compare
these 4 results.

Note that errors are
reported with the
results. This is
crucial.

Results and Discussion - Graphs

- Use graphs liberally
....to display raw data

Provide a key if more than one set of data is shown. This key would be better if it were clearer.

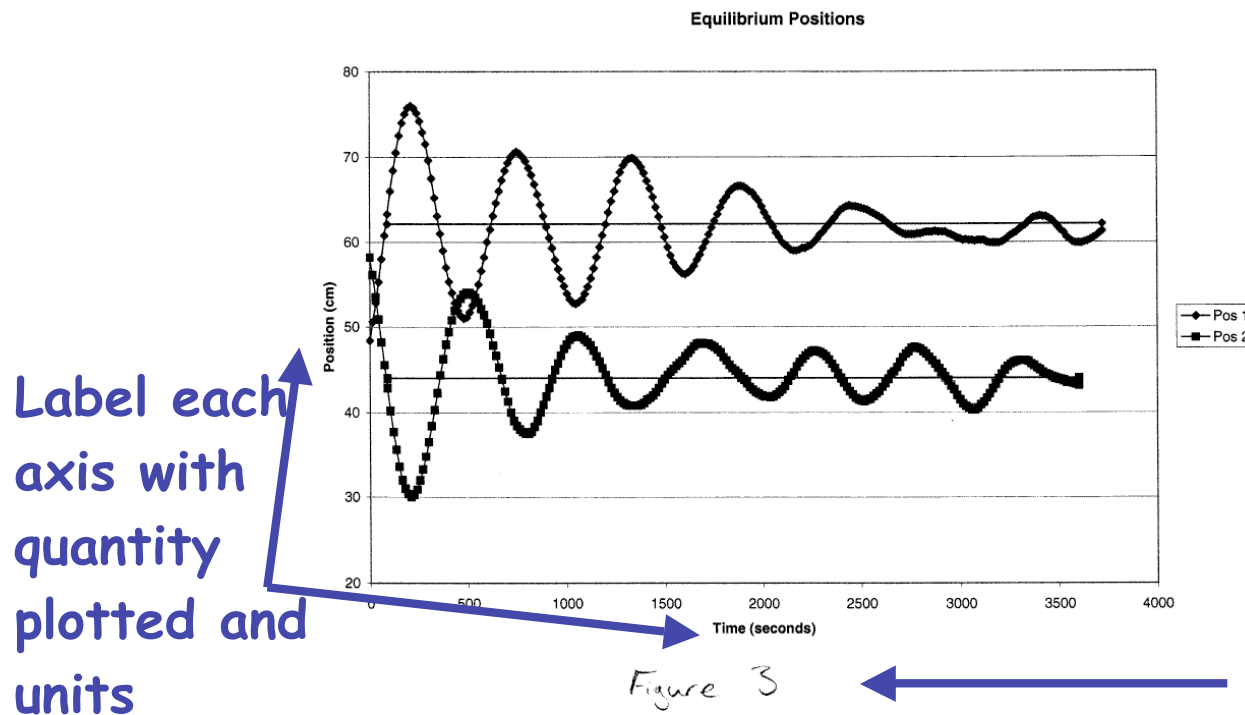

Uh oh. Forgot caption.

This plot is **excellent**. By superimposing data from two runs the author has communicated a **LOT** about data stability.

Results and Discussion - Graphs

- Use graphs liberally
....to display raw data

Figure 2. Amplitude as a function of frequency for four values of the damping current.

Index?
Ticks?

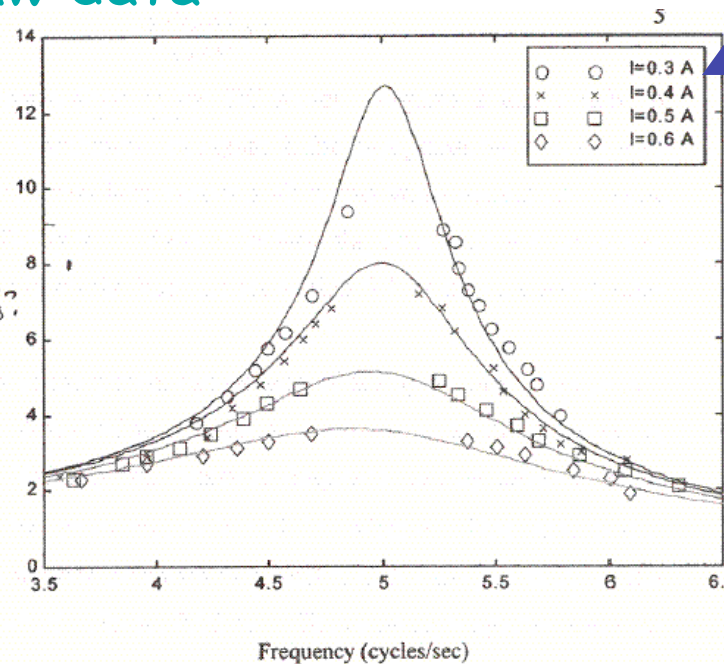

Nice key. But theory curves should also be labelled.

Very nice
Oops. Forgot axis label.

This plot makes trends in the data immediately clear.

Results and Discussion - Graphs

...to compare data with theory

Be sure to provide the functional form of theory curves...either in the key or in the text.

Include error bars on points whenever possible.

Oops.
Forgot units

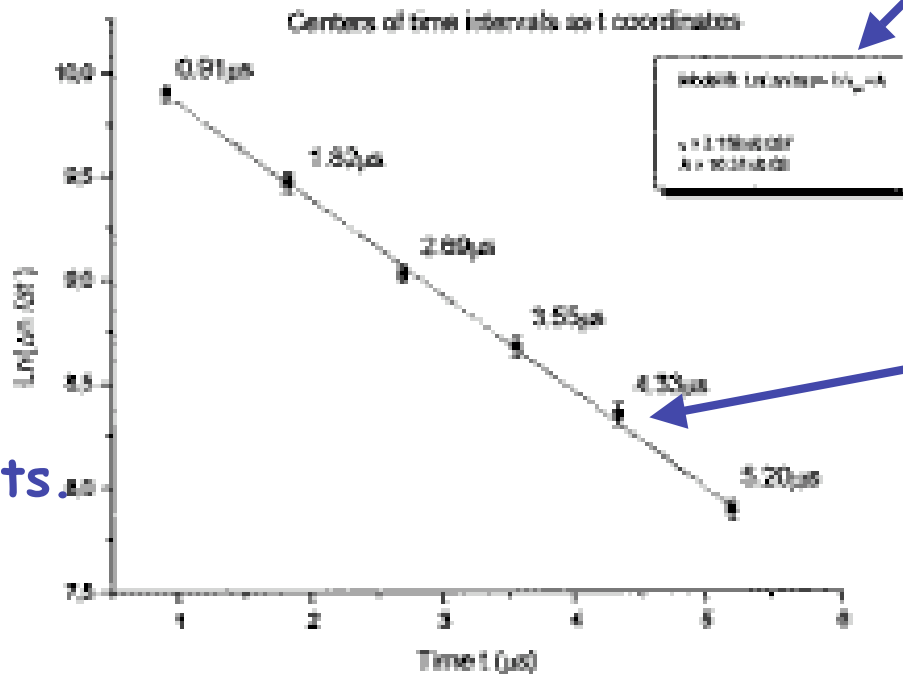
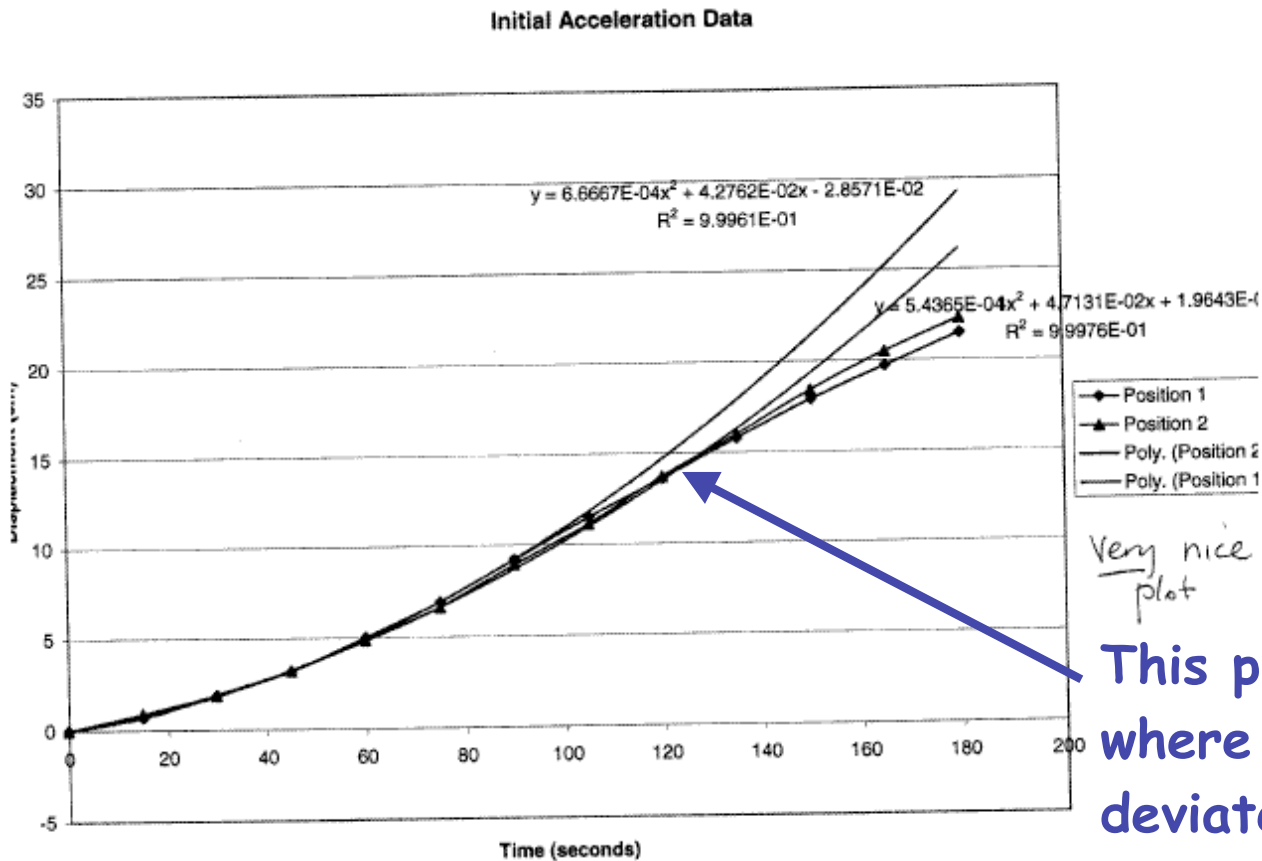

Figure 4. Natural logarithm of the average decay rate versus centers of the corresponding time intervals.

How large should the graph be? Large enough for the important features to be visible.

Results and Discussion - Graphs

- ...to look for problems in the data



Very nice
plot

This plot shows where the data deviate from theory. The text explains why.

Oops. No caption.

Results and Discussion - Graphs

- ...to show the effect of a correction

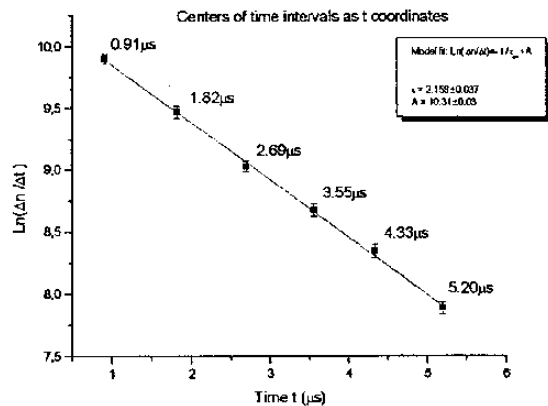

Figure 4. Natural logarithm of the average decay rate versus centers of the corresponding time intervals.

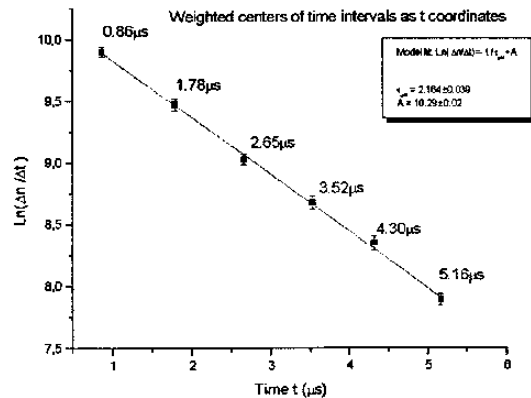
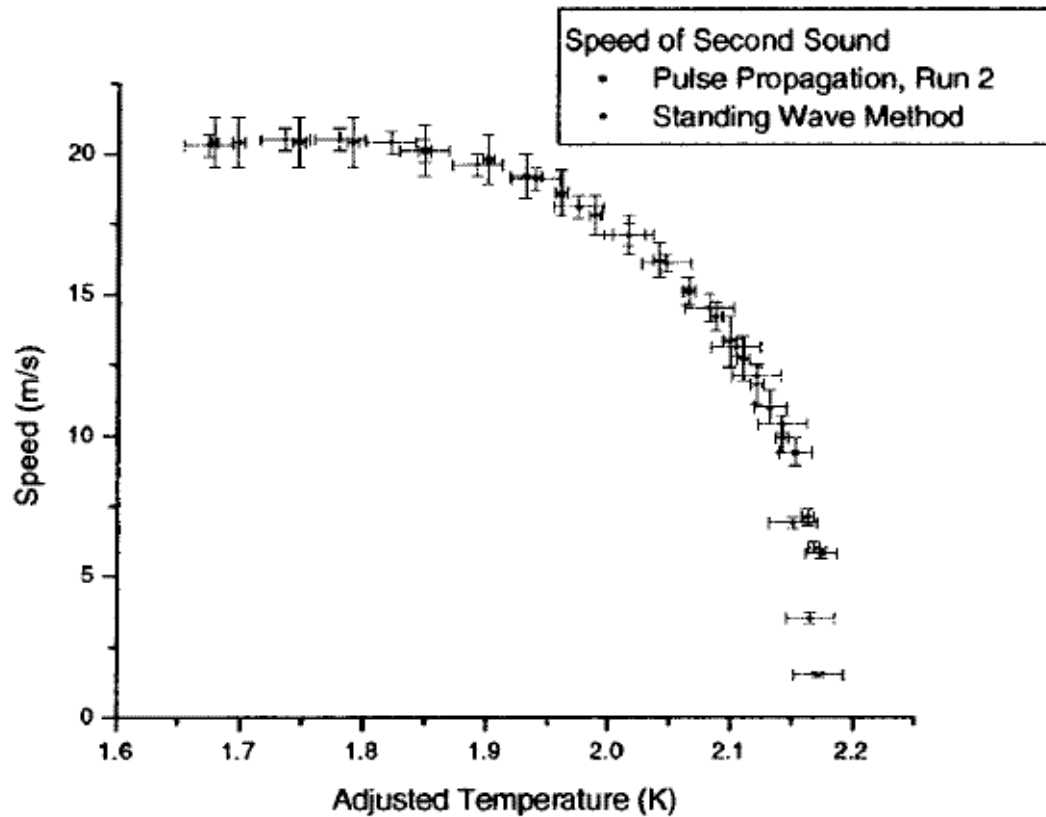

Figure 5. Natural logarithm of the average decay rate versus weighted centers of the corresponding time intervals.

Here, a correction has been applied to the data in the lower plot. Had the student superimposed these two graphs, the effect of the correction would have been much clearer.

Results and Discussion - Graphs

- ...to compare two techniques



Here, data sets obtained using two different techniques are superimposed. This is a superb way to compare them, and should always be done...even when the agreement isn't great.

HINT: If the agreement is poor, explore reasons **WHY**.

In excellent reports, the student puts a lot of effort into to explaining quirks in the data.

Errors

Explain how each error is evaluated

...from counting statistics

are correlated (since one includes another), therefore, [the statistical error for the number of decays Δn_i can be calculated as $\sqrt{\Delta n_i}$] In this experiment, the relative error was within 2% for

...from a reference

we do not know the energy spectrum of incident muons [The ratio of positively and negatively charged muons $\mu^+/\mu^- = 1.06 \pm 0.03$ measured by Morewitz and Shamos [3]] at sea level for the

...from a fit

can be used as t_i values (table 3) [In this case, the weighted fit with errors on each data point yields the value of $\tau_{\text{exp}} = 2.158 \pm 0.037 \mu\text{s}$ (figure 4).] Then, it is possible to improve our guess for t_i

Errors

... or from sensible estimates

The error in the determination of t_0 and t_1 is the error in the measurement of the delay time between pulses by oscilloscope (approximately $0.02 \mu\text{s}$) and the uncertainty in the electronics triggering. Since the electronics triggers on the front edge of the input pulse, this

The error on the value of S was tricky to determine. I used a data set based on the peak to peak average of each cycle, and found a standard deviation for each position. I then added these errors to find the error in S . Again, the last row shows the values of G when

When the error estimation is straight-forward, it generally works best to estimate the error right when you introduce the value. From then on, quote the error with the number every time.

Keeping Track of Errors

Table 3. Data used for the determination of the effective muon lifetime.

Consecutive time intervals	#1	#2	#3	#4	#5	#6
Edges (μs)	0.40-1.41	1.41-2.22	2.22-3.16	3.16-3.94	3.94-4.72	4.72-5.68
Width Δt_i (μs)	1.01 ± 0.04	0.81 ± 0.04	0.94 ± 0.04	0.78 ± 0.04	0.78 ± 0.04	0.96 ± 0.04
Differential number of decays Δn_i	20168 ± 142 (0.7%)	10541 ± 103 (1.0%)	7853 ± 89 (1.1%)	4594 ± 68 (1.5%)	3305 ± 58 (1.7%)	2563 ± 51 (2.0%)
$\Delta n_i / \Delta t_i$ ($1/\mu\text{s}$)	19968 ± 803 (4.0%)	13014 ± 655 (5.0%)	8354 ± 368 (4.4%)	5890 ± 314 (5.3%)	4237 ± 230 (5.4%)	2670 ± 123 (4.6%)
Center θ_i of the time interval (μs)	0.92 ± 0.02	1.82 ± 0.02	2.70 ± 0.02	3.55 ± 0.02	4.33 ± 0.02	5.20 ± 0.02
Weighted center θ_i^w of the time interval (μs)	0.86 ± 0.05	1.79 ± 0.05	2.65 ± 0.06	3.52 ± 0.06	4.30 ± 0.07	5.16 ± 0.07

Relative errors are indicated in parentheses.

This table includes the errors in each line.

Numbers

Right:

$$0.86 \pm 0.05 \mu\text{s}$$

$$(1.29 \pm 0.09) \times 10^4 \text{ m}$$

$$(7.06 \pm 0.10) \times 10^{-2} \text{ m}$$

$$0.001 \pm 0.007 \mu\text{m}$$

Wrong:

$$0.79 \pm 0.4 \mu\text{s}$$

$$0.7 \pm 0.12 \mu\text{s}$$

$$0.792 \pm 0.432 \mu\text{s}$$

$$1.29 \text{ m} \pm 2 \text{ cm}$$

Results and Discussion

- Consider sources of bias

- ... and then suppress them

correction factor β has been applied. Averaging the two values to compensate for other

other gravitational influences gives a final result of $6.86 \times 10^{-11} \pm 0.43 \times 10^{-11} \text{ m}^2 \text{ kg}^{-1} \text{ s}^{-2}$ for

- ... or quantify them

Random counts can be described by the Poisson statistics. The probability of the second pulse detection after the first pulse within the time interval ΔT is

$$P_{\Delta T}(2) = \frac{m^2}{2!} e^{-m} \quad (8)$$

where m is the mean value of counts detected within the time interval ΔT . For the longest time bin #6 $\Delta T \approx 5.68 \mu\text{s}^*$ and $m = r\Delta T \approx 6.04 \times 10^{-5}$ counts, (8) yields the probability of 3.7×10^{-10} . The product of the obtained probability and the total number of single pulses observed during the experiment gives the number of background counts in time bin #6. It was found to be approximately 0.04 counts. The number of the background counts in the time bins #1-5 is even

Really excellent reports are really quantitative

Results and Discussion

- Try to understand the data.

about three peaks were nicely shaped and discernable; the shape of the response pulses was very much deformed from the sort of smoothly damped oscillations we might have expected to see¹⁰, at least as we would from a sharp impulse. Two likely reasons are: 1) Since the repetition rate of the oscillator may not be sufficiently low, for a given pulse's response we

sequence from the pulse generator into the negative input in the run mode. [When the pulses from the photomultiplier are fed into it, a different situation is observed - the value of "Total B" is slightly smaller than the value of "Total A". The probable reason of this situation could be the following. The signal from the PMTs is weak and noisy, and the slight discrepancy in the thresholds of "Total A" and "Total B" triggering can lead to such behavior. In any case, this fact does not affect the statistics of the detected muon decays.

Good observation!

Notice places where the data behave unexpectedly,
and use them to learn about the system.

Conclusions

- Compare your result with expectation, if you haven't already done so.

Be aware that the odds of deviating from truth by
(SD = Standard Deviation)

>1 SD are 32% (by def of SD)

>2 SD are 5%

>3 SD are 0.3%

If your result deviates from expectation by >2-3 SD,
take it seriously.

- Point out changes in the experimental technique that would improve the results. Even better, **quantify** the size of the improvement.